

Perspektive

Schloss: T-AV3-F167769 .../D A9 92/... M2 RS
DIN LS spiegelbildlich

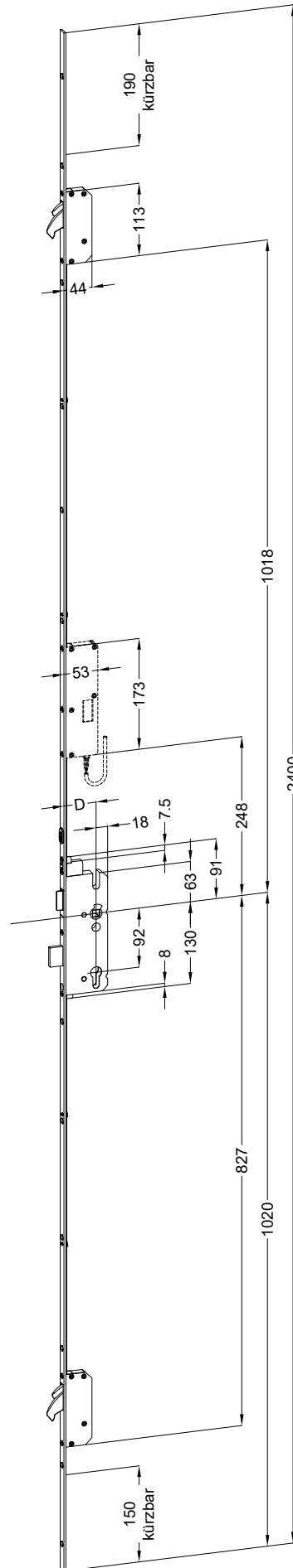

Technische Änderungen vorbehalten!

Schraublage
Schloss: T-AV3-F167769 .../D A9 92/... M2 RS
DIN LS spiegelbildlich

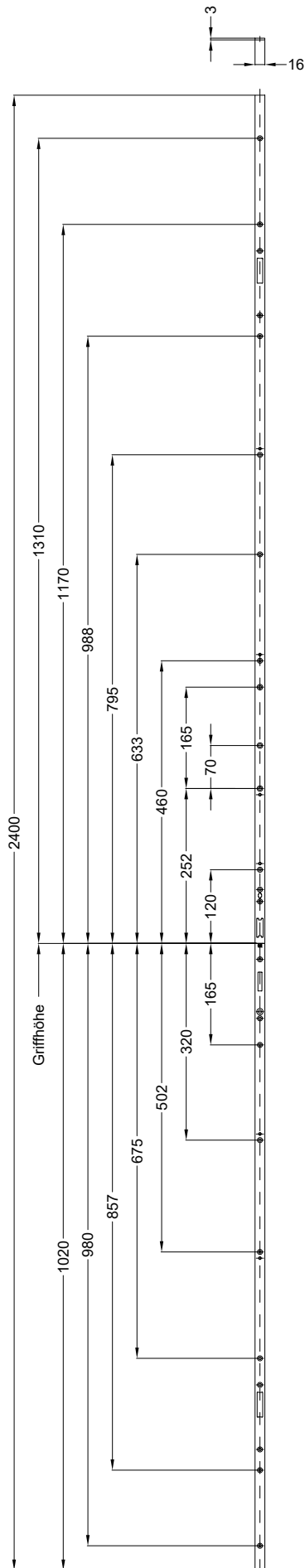

Ansichten

Schloss: T-AV3-F167769 .../D A9 92/... M2 RS
DIN LS spiegelbildlich

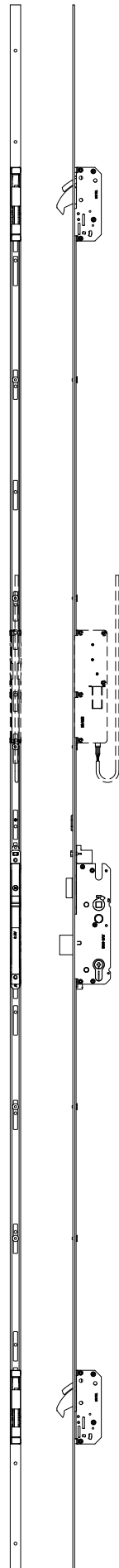

Technische Änderungen vorbehalten!

Fräsmaße

PSchloss: T-AV3-F167769 .../D A9 92/... M2 RS
DIN LS spiegelbildlich

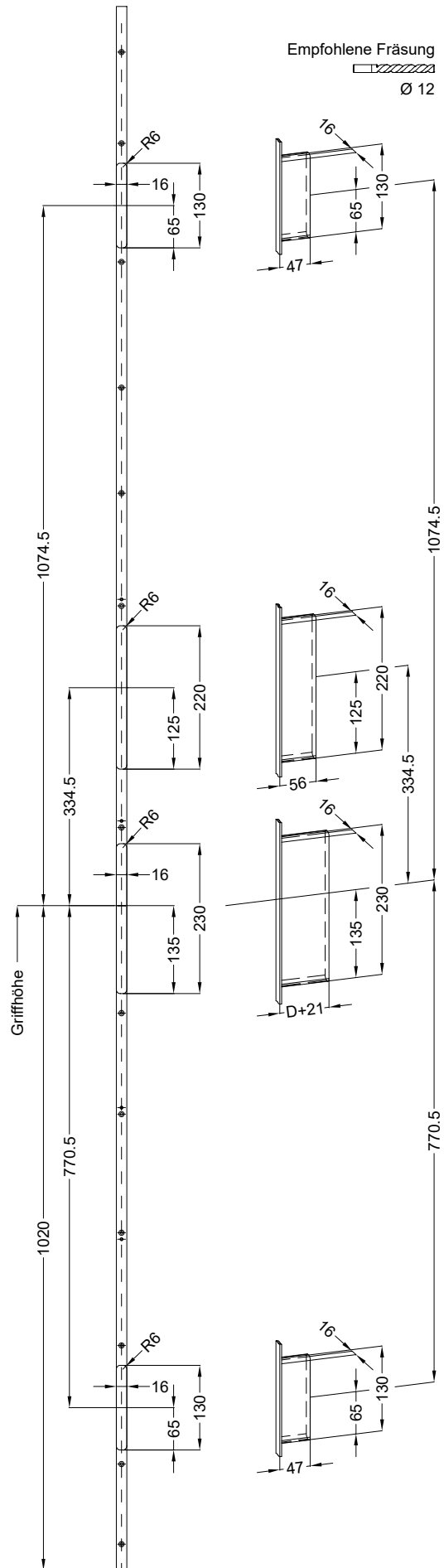

Technische Änderungen vorbehalten!

Allgemeine Vermaßung

Fräsmaße

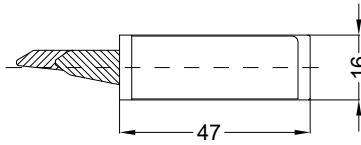
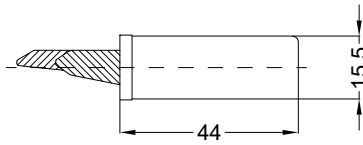

Situation
Schwenkriegel

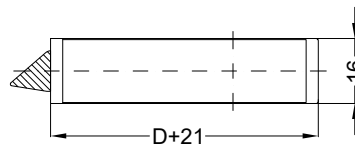
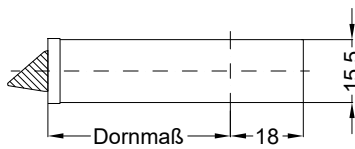

Situation
Falle

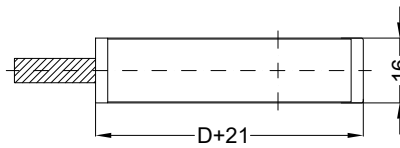
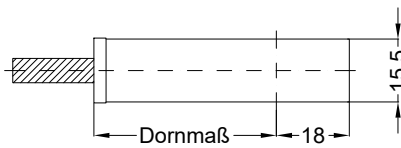

Situation
Riegel

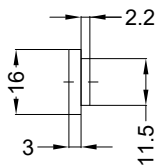

Lage
Schloss

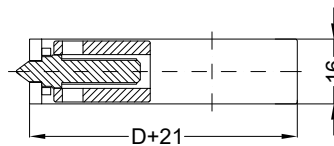
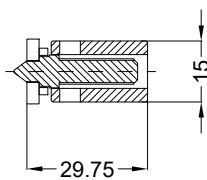

Situation
Taststift

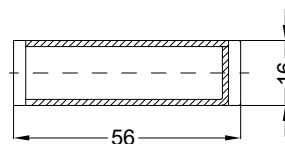
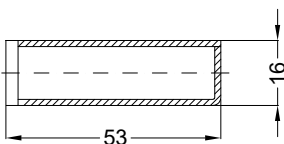

Situation
Motorkasten

Katalogdarstellung

Schloss: T-AV3-F167769 .../D A9 92/... M2 RS
DIN LS spiegelbildlich

