

Perspektive
Schloss: T-F2060 .../D 92/... M4

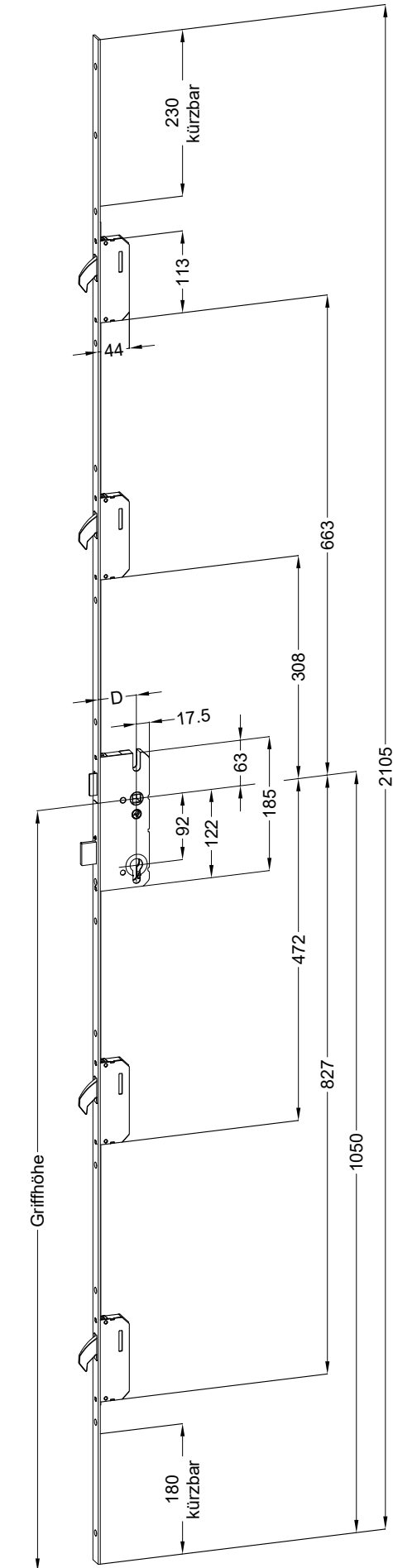

Schraublage
Schloss: T-F2060 .../D 92/... M4

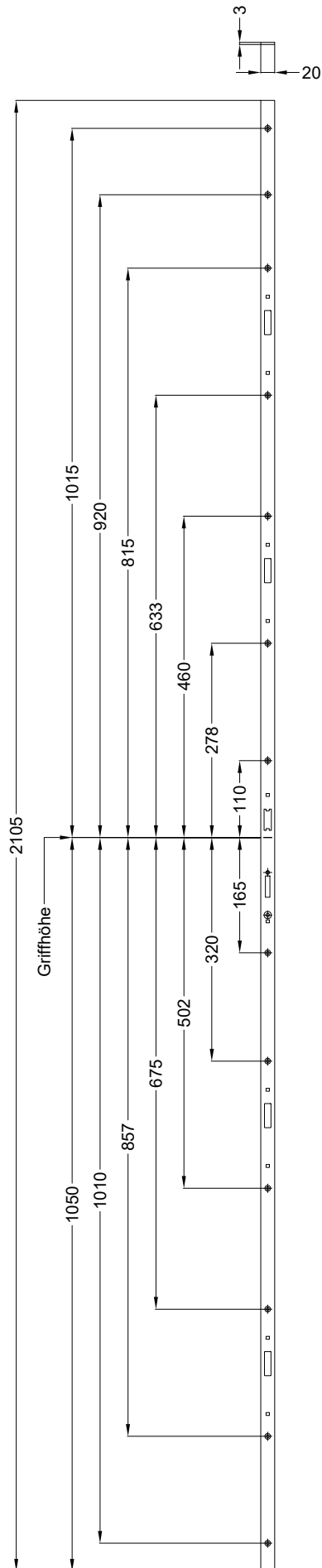

Ansichten

Schloss: T-F2060 .../D 92/... M4

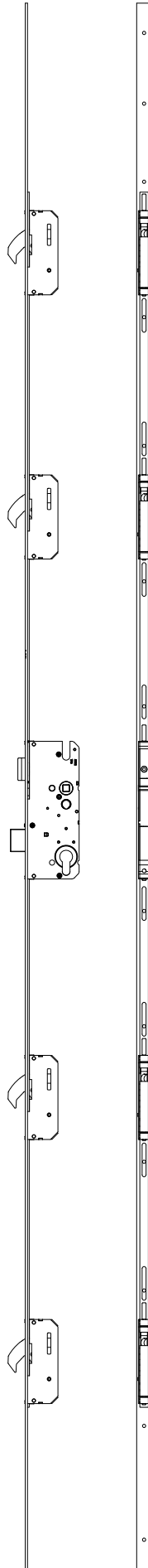

Allgemeine Vermaung

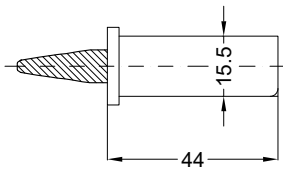

Frsmae

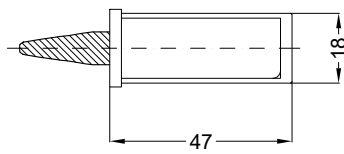

Situation
 Schwenkriegel

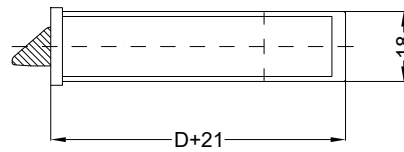
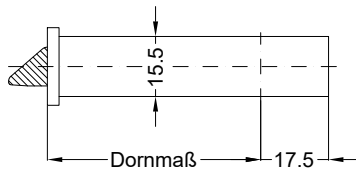

Situation
 Falle

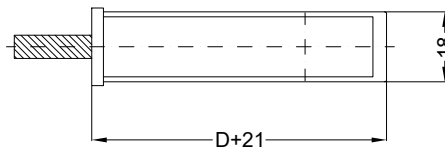
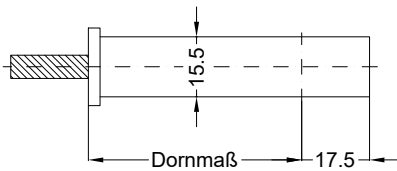

Situation
 Riegel

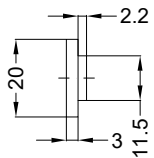

Lage
 Schloss

