

Perspektive
Schloss:

T-AV3OR-F1660 .../D A9 92/... M2 RS
DIN LS spiegelbildlich

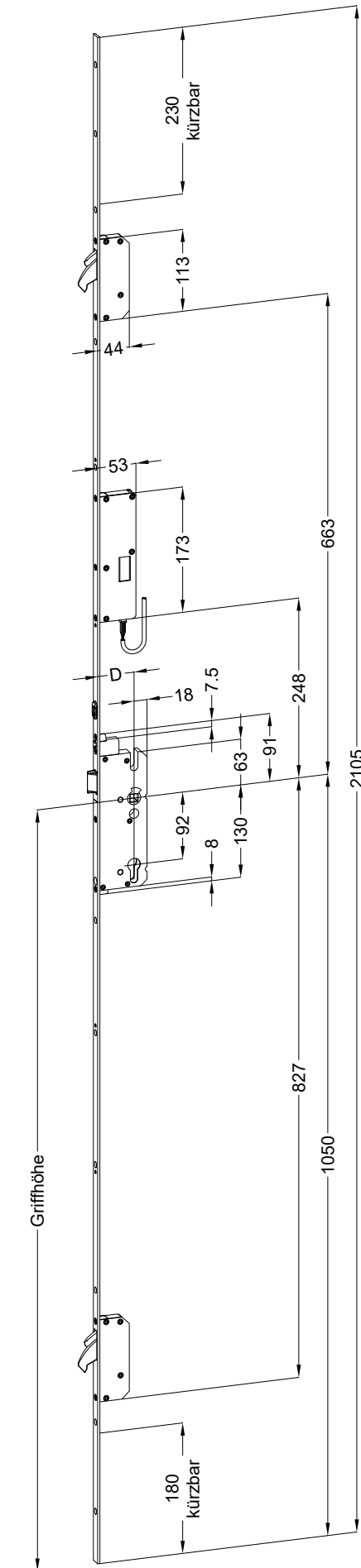

Technische Änderungen vorbehalten!

Ansichten
Schloss:

T-AV3OR-F1660 .../D A9 92/... M2 RS
DIN LS spiegelbildlich

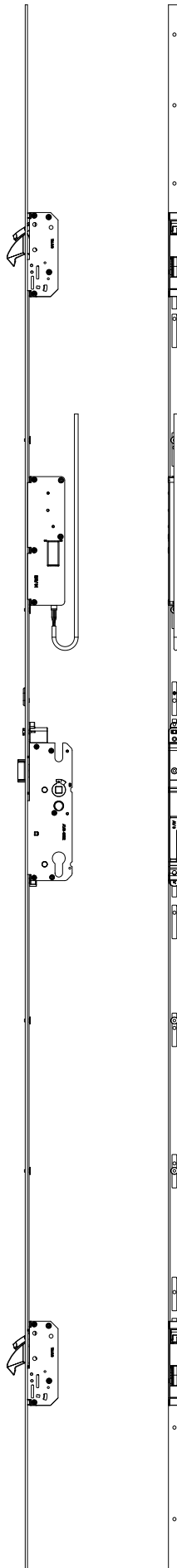

Technische Änderungen vorbehalten!

Einbausituationen der Bauteile mit Fräsmaßen

Schloss: T-AV3OR-F1660 .../D A9 92/... M2 RS
DIN LS spiegelbildlich



Allgemeine Vermaung

Frsmae

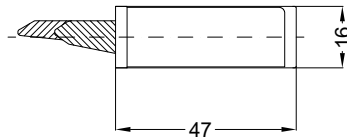
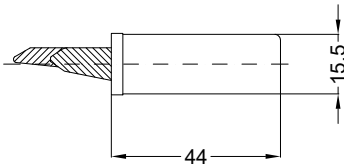

Situation
Schwenkriegel

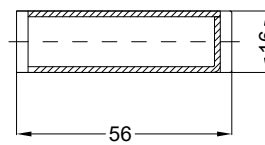
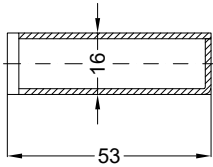

Situation
Motorkasten EAV

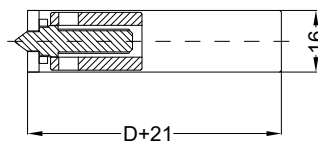
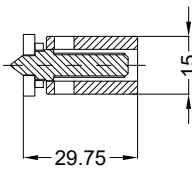

Situation
Taststift

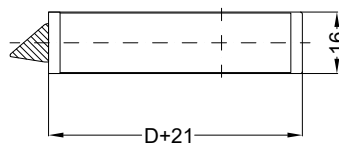
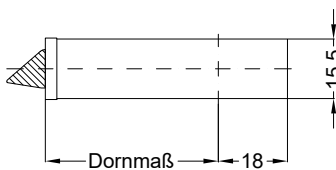

Situation
Falle

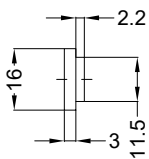

Lage
Schloss

Katalogdarstellung

Schloss: T-AV3OR-F1660 .../D A9 92/... M2 RS
DIN LS spiegelbildlich

