

Perspektive
Schloss:

T AV3-F2060 .../D A9 92/... M4 RS
DIN LS spiegelbildlich

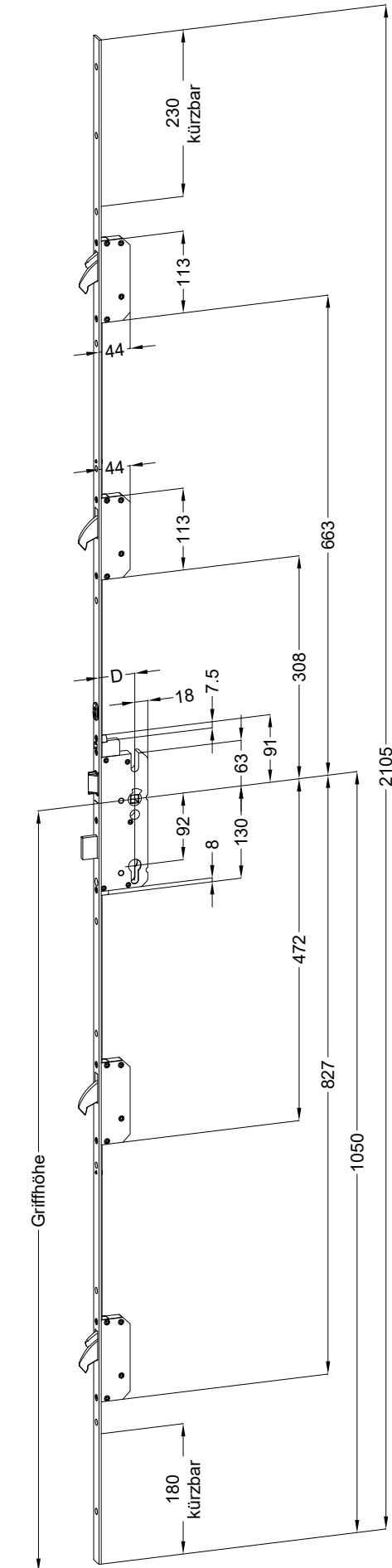

Technische Änderungen vorbehalten!

Schraublage
Schloss:

T AV3-F2060 .../D A9 92/... M4 RS
DIN LS spiegelbildlich

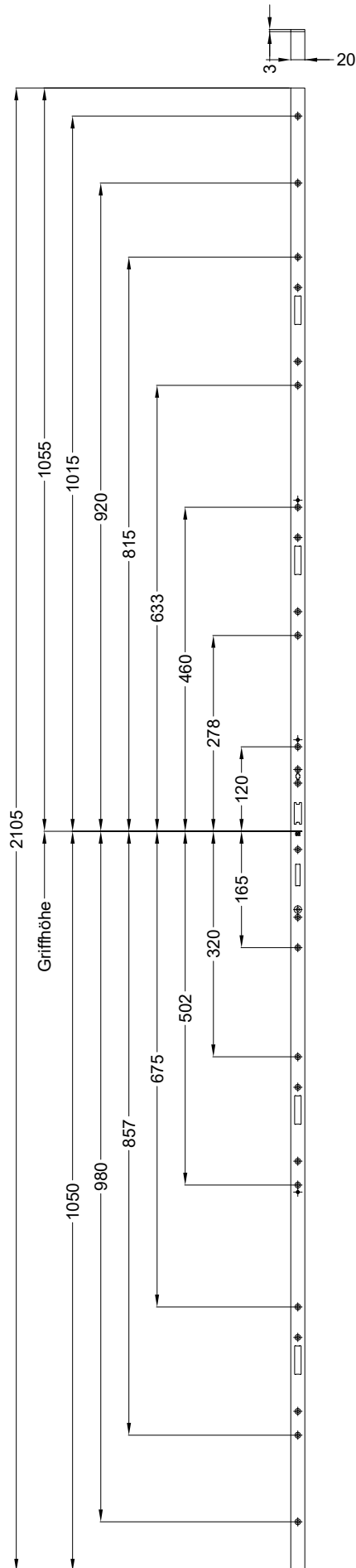

Technische Änderungen vorbehalten!

Ansichten
Schloss:

T AV3-F2060 .../D A9 92/... M4 RS
DIN LS spiegelbildlich

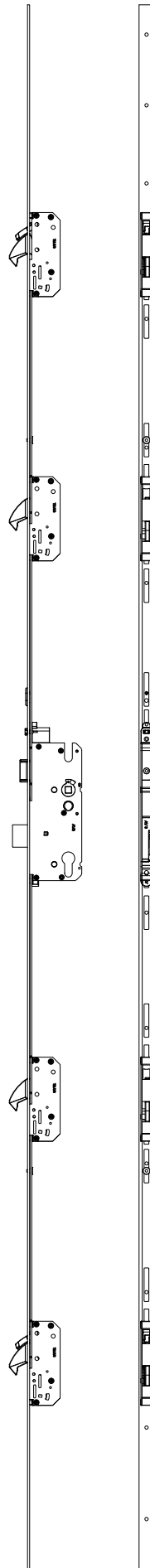

Technische Änderungen vorbehalten!

Einbausituationen der Bauteile mit Fräsmaßen

**Schloss: T AV3-F2060 .../D A9 92/... M4 RS
DIN LS spiegelbildlich**



Allgemeine Vermaßung

Fräsmaße

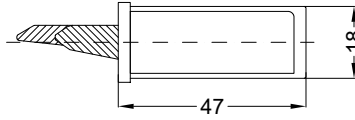
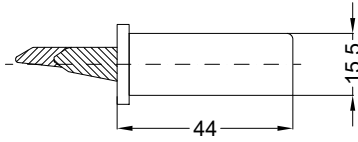

Situation
Schwenkriegel
TM AV3 SK RS

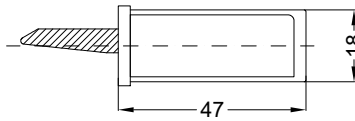
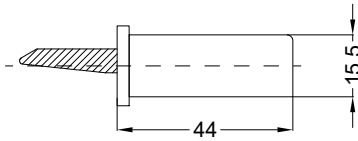

Situation
Schwenkriegel
TM AV3 SK OAR

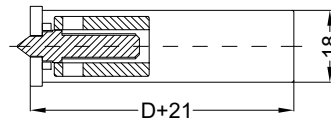
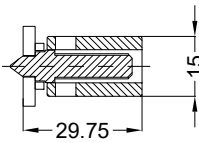

Situation
Taststift
SK AV3

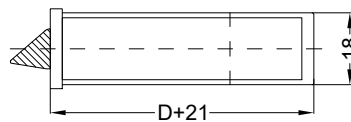
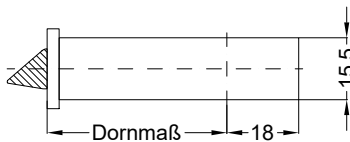

Situation
Falle
SK AV3

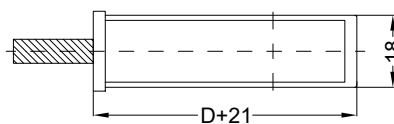
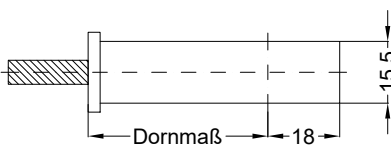

Situation
Riegel
SK AV3

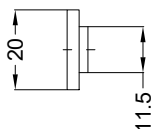

Lage
Schloss

Katalogdarstellung

Schloss: T AV3-F2060 .../D A9 92/... M4 RS
DIN LS spiegelbildlich

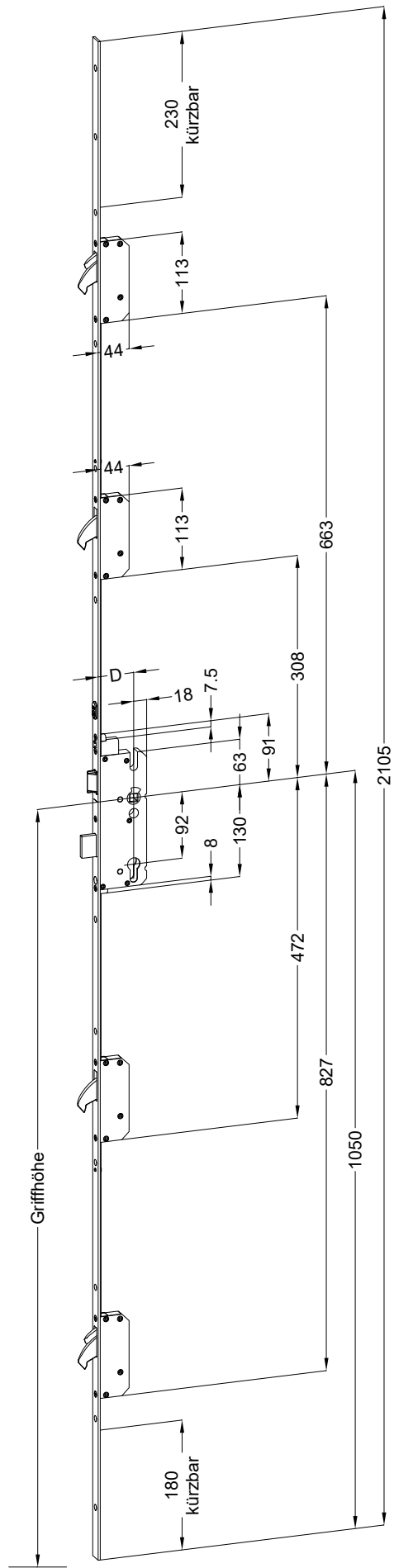

Empfohlene Fräsung

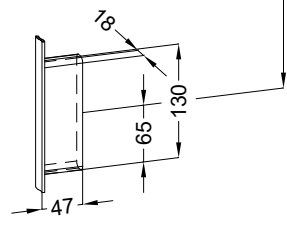
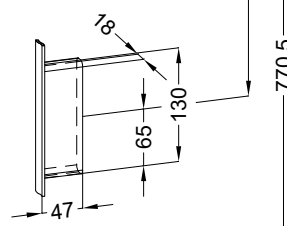
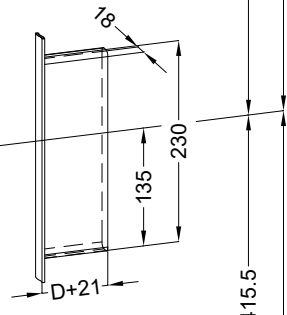
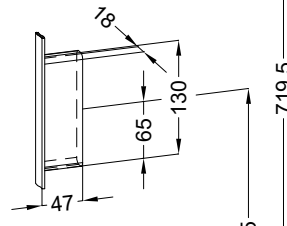
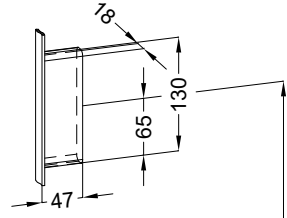
 Ø 12



Technische Änderungen vorbehalten!