

Schraubblage
Schloss: T-F2060 .../D 92/... R4

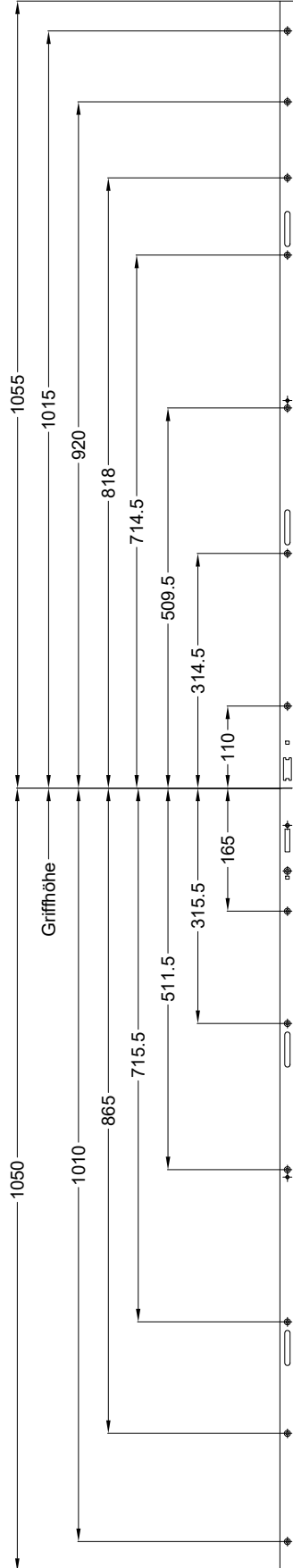

Ansichten

Schloss: T-F2060 .../D 92/... R4

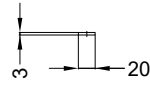

Technische Änderungen vorbehalten!

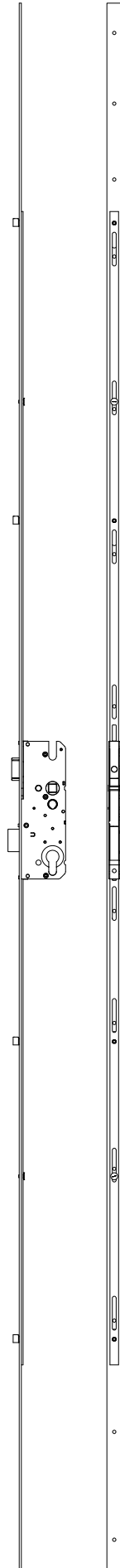

Fräsmaße

Schloss: T-F2060 .../D 92/... R4

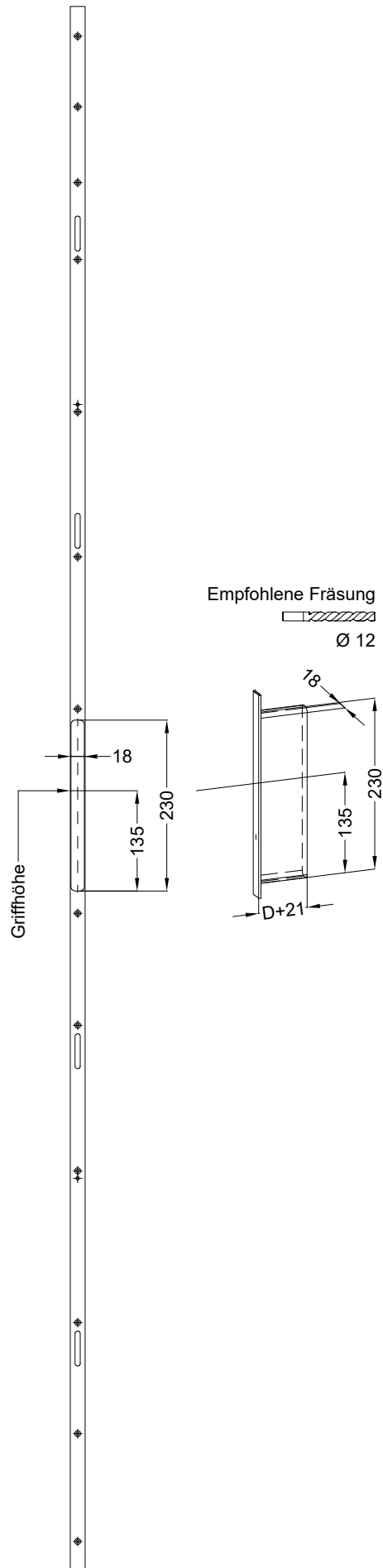

Allgemeine Vermaung

Frsmae

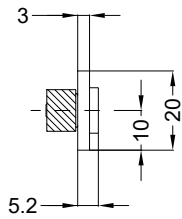

Situation
 Exzenterbolzen

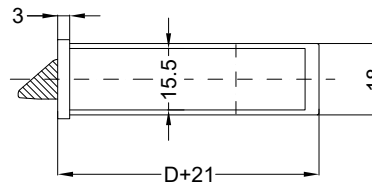
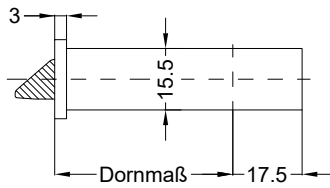

Situation
 Falle

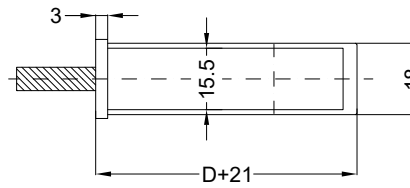
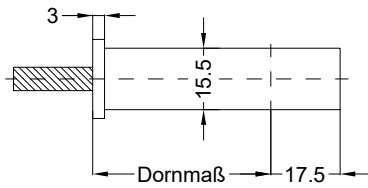

Situation
 Riegel

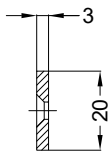

Lage
 Schloss

