

Perspektive  
Schloss:

T-AV3-UW24184 .../D A9 92/... M2 RS  
DIN LS spiegelbildlich

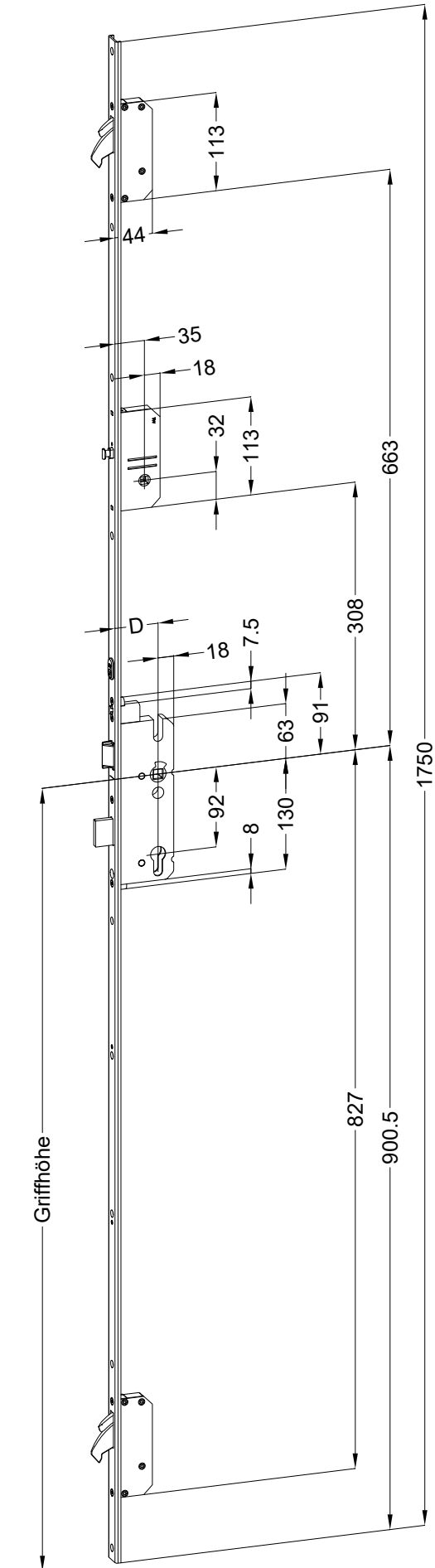

Technische Änderungen vorbehalten!

Schraublage  
Schloss:

T-AV3-UW24184 .../D A9 92/... M2 RS  
DIN LS spiegelbildlich

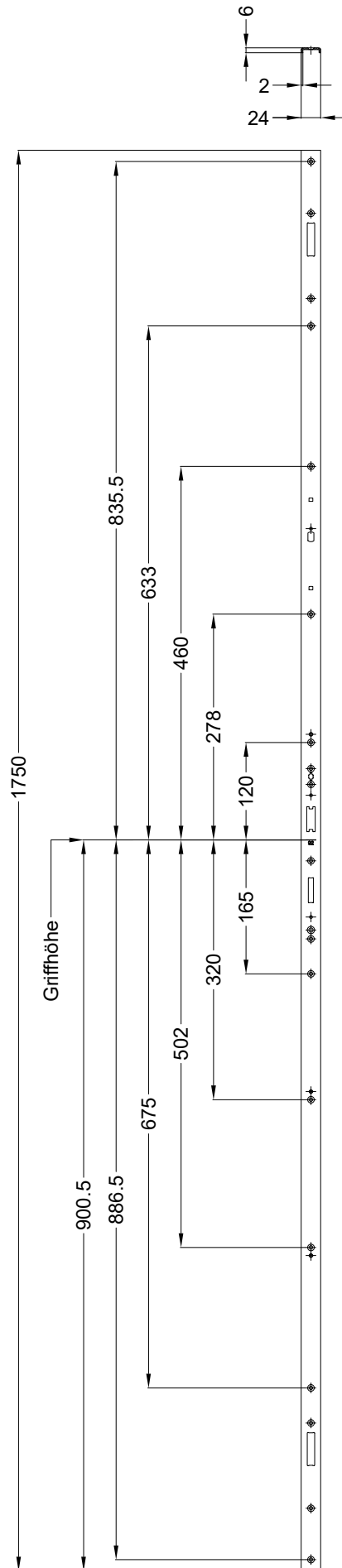

Technische Änderungen vorbehalten!

Ansichten  
Schloss:

T-AV3-UW24184 .../D A9 92/... M2 RS  
DIN LS spiegelbildlich

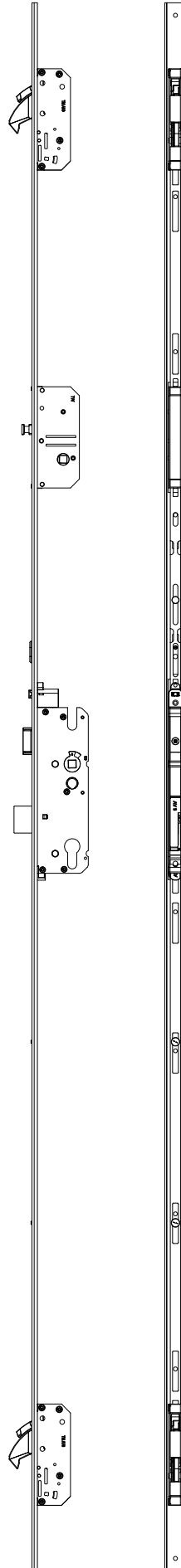

Technische Änderungen vorbehalten!



**Einbausituationen der Bauteile mit Fräsmaßen**

**Schloss: T-AV3-UW24184 .../D A9 92/... M2 RS  
DIN LS spiegelbildlich**



**Allgemeine Vermaung**

**Frsmae**

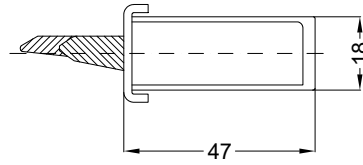
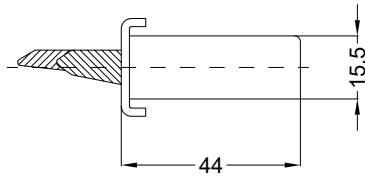

Situation  
Schwenkriegel  
TM AV3 SK RS

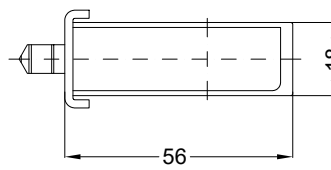
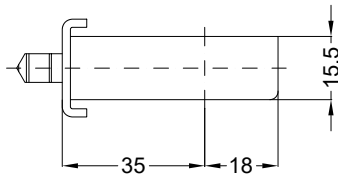

Situation  
Trwchter

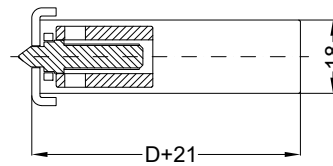
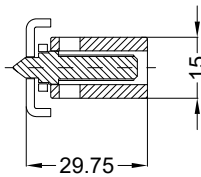

Situation  
Taststift  
SK AV3

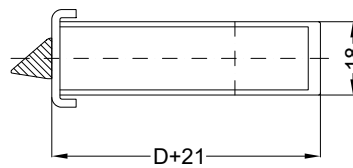
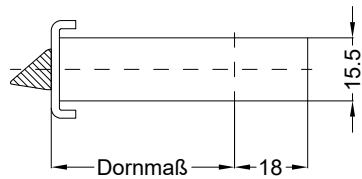

Situation  
Falle  
SK AV3

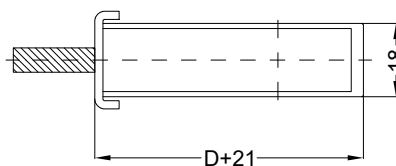
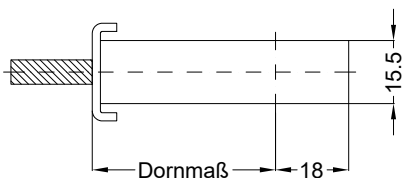

Situation  
Riegel  
SK AV3

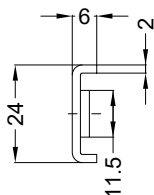

Lage  
Schloss

Katalogdarstellung

Schloss: T-AV3-UW24184 .../D A9 92/... M2 RS  
 DIN LS spiegelbildlich

