

Ⓓ Bedienungsanleitung

ⒼⒷ Installation instructions

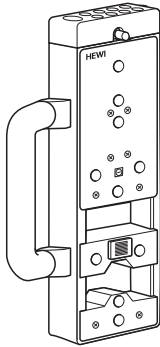

**Bohrlehre  
Installation jig**

1

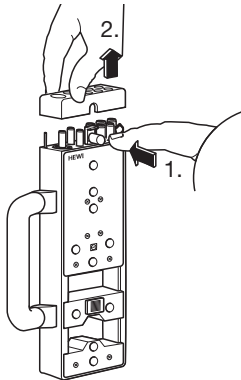

2

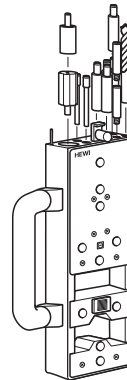

ø 22 mm KABA (Schweiz | Switzerland)



ø 17 mm Profilylinder (PZ) | Euro cylinder



ø 10 mm Zentrierdorn | centering pin



ø 9 mm Zentrierdorn | centering pin



ø 8,5 mm Zentrierdorn | centering pin  
(Österreich | Austria)



ø 8 mm Zentrierdorn | centering pin



ø 8 mm Zentrierdorn | centering pin



ø 7 mm geteilter Zentrierdorn, auch als  
Verlängerung nutzbar | split centering  
pin, also usable as extension



ø 6 mm Zentrierdorn | centering pin



ø 5 mm Zentrierdorn | centering pin



Bohrer | drill bit

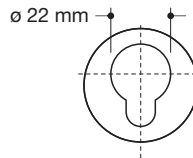
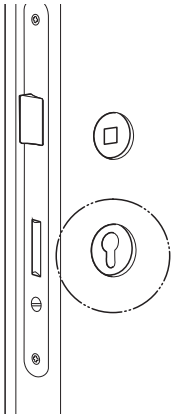
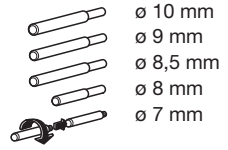
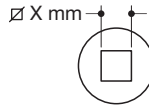
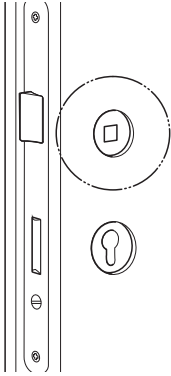

KABA  
∅ 22 mm

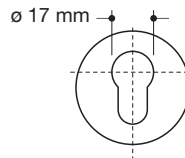

Profilzylinder (PZ)  
Euro cylinder  
∅ 17 mm

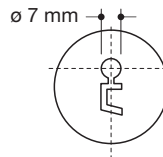

Buntbart (BB)  
Lever key  
∅ 7 mm

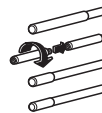
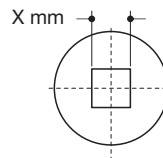

WC (NR/FB)  
vacant/engaged  
∅ 8 mm  
∅ 7 mm  
∅ 6 mm  
∅ 5 mm

1

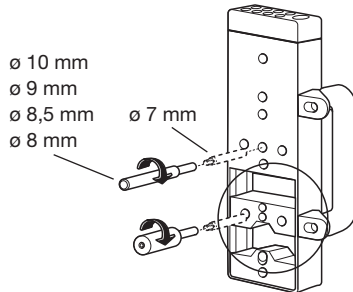

2a

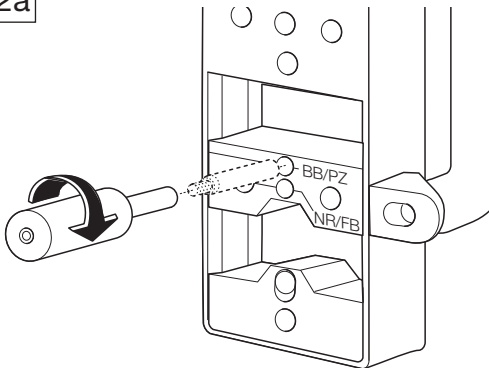

- Buntbart (BB)  
Lever key
- Profilzylinder (PZ)  
Euro cylinder
- KABA

2b

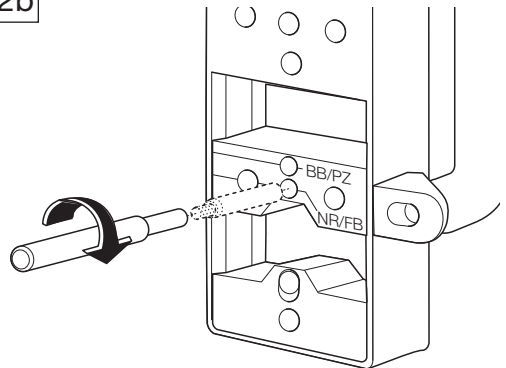

- WC (NR/FB)  
vacant/engaged

1

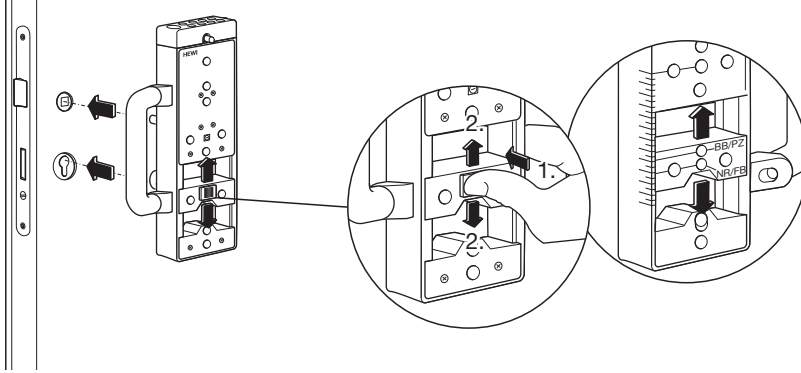

2

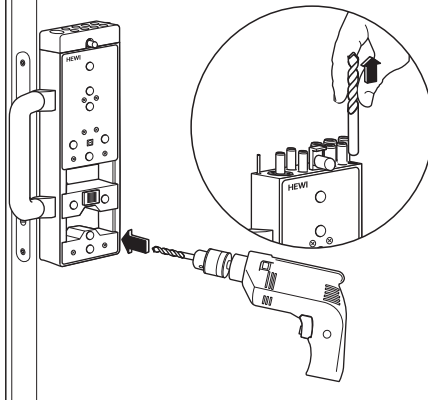

3

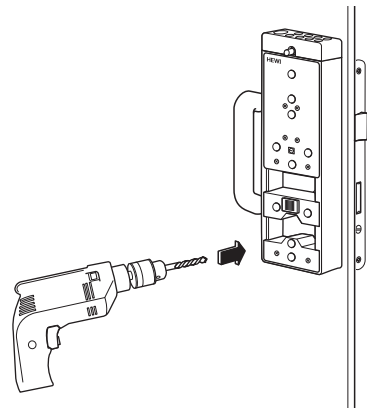

 Achtung!

Nicht in oder durch den Schlosskasten bohren!



 Very important to note!

Do not drill into or through the lockcase!



**Rosette**

**roses**

- 305...
- 306...
- 307...
- 308...

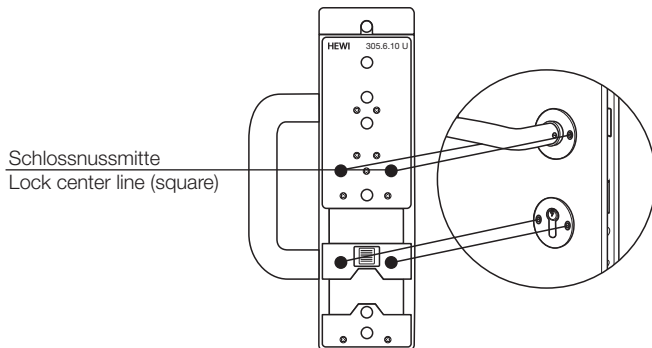

**Schild**

**backplate**

- 217...R
- 230...R 230...H
- 285...R

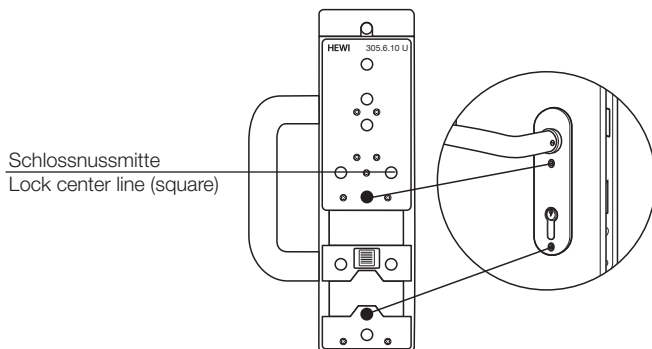

**Schutzbeschlag (Kurzschild)**

**Security backplate (short)**

- ...ES1

mit Bohrer  $\varnothing$  10,5 mm nachbohren.  
redrill with drill bit  $\varnothing$  10,5 mm.

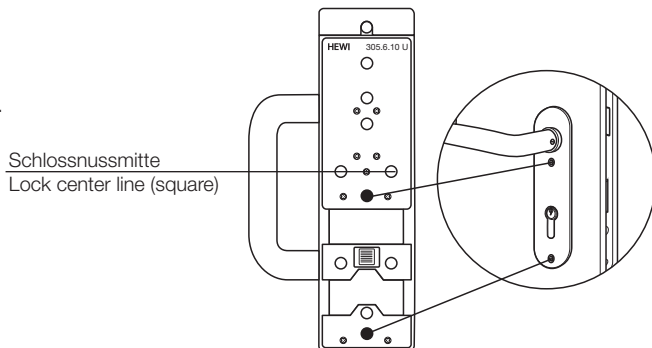

**Schild  
backplate**  
230...E

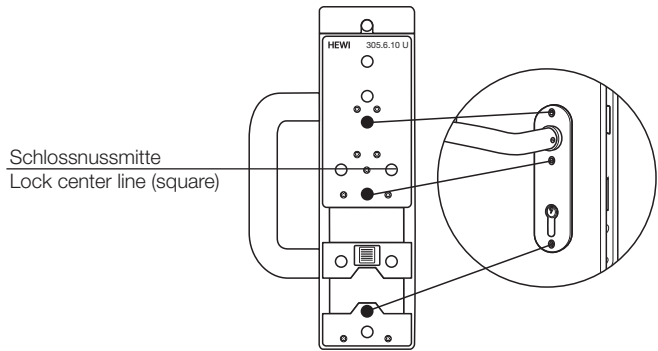

**Schild  
backplate**  
235...R 219...H  
220...H  
235...H  
236...H

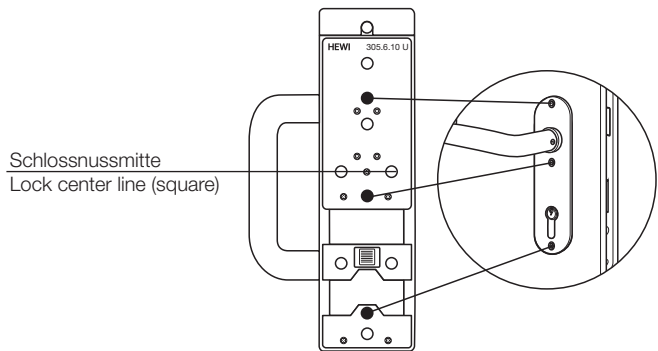

**Schutzbeschlag (Langschild)**  
**Security backplate (long)**  
...ES3

mit Bohrer  $\varnothing$  10,5 mm nachbohren.  
redrill with drill bit  $\varnothing$  10,5 mm.

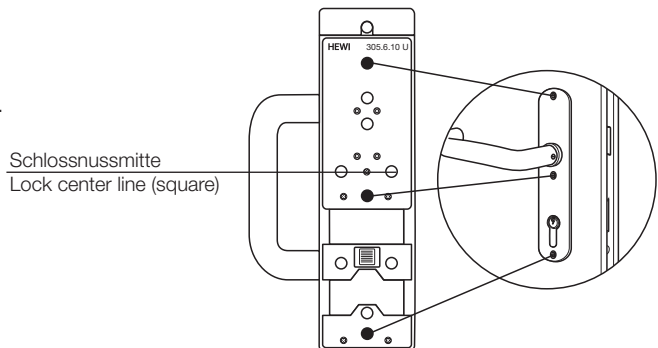

# HEWI

[www.hewi.com](http://www.hewi.com)

## **Deutschland**

HEWI Heinrich Wilke GmbH

Postfach 1260

D-34442 Bad Arolsen

Telefon: +49 5691 82-0

Telefax: +49 5691 82-319

[info@hewi.de](mailto:info@hewi.de)