

Schraublage  
Schloss:

T-F2070 .../DS 92/... M2

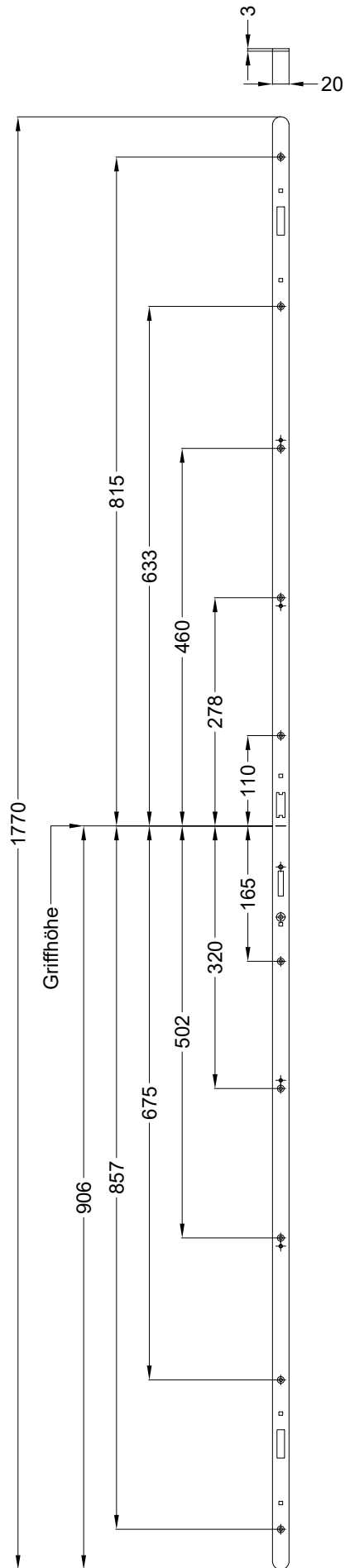

Technische Änderungen vorbehalten!

**Ansichten**  
**Schloss:**

**T-F2070 .../DS 92/... M2**

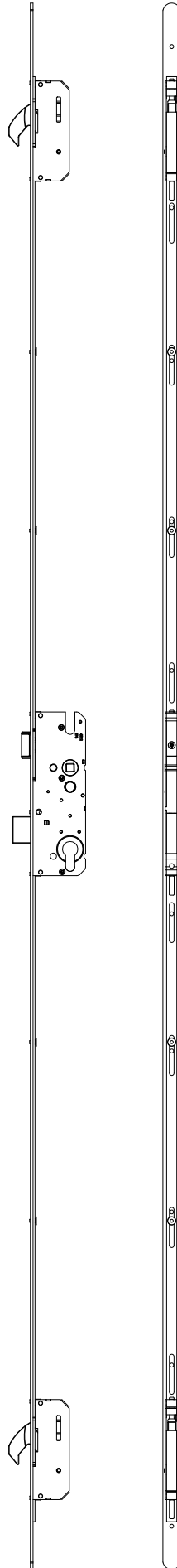

Technische Änderungen vorbehalten!

Empfohlene Fräsung

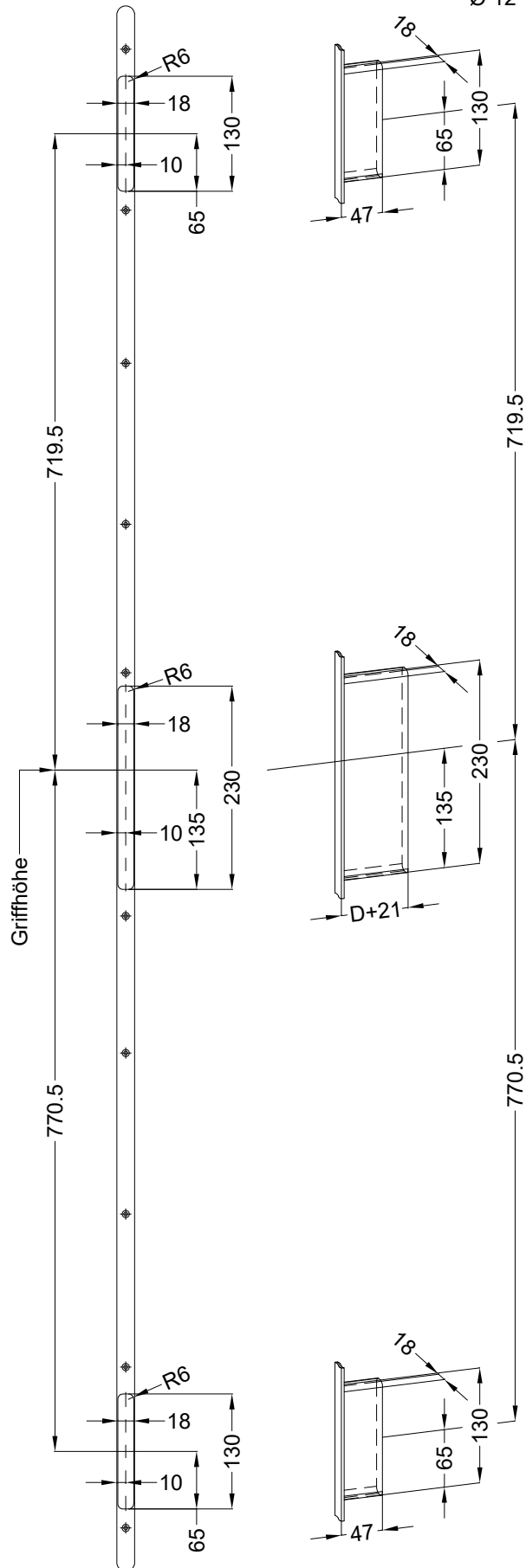
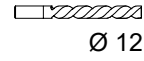

Allgemeine Vermaung

Frsmae

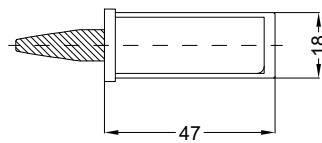
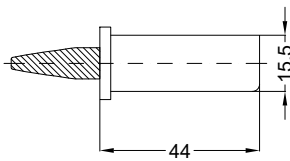

Situation  
 Schwenkriegel  
 G1 Gehuse TM6 Y2K

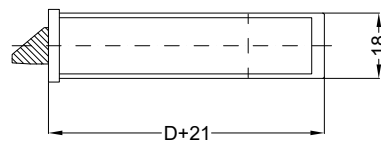
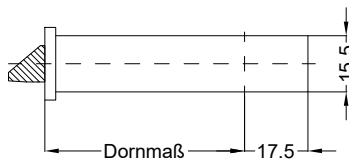

Situation  
 Falle  
 SK TP3

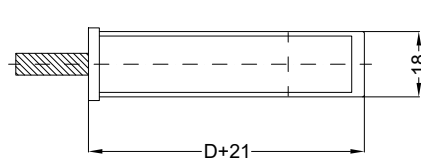
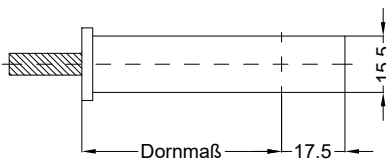

Situation  
 Riegel  
 SK TP3

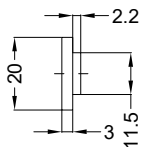

Lage  
 Schloss

Empfohlene Fräsung



Ø 12

