

Perspektive

Schloss: T-F2460 .../D 92/... M4 RS
DIN LS spiegelbildlich

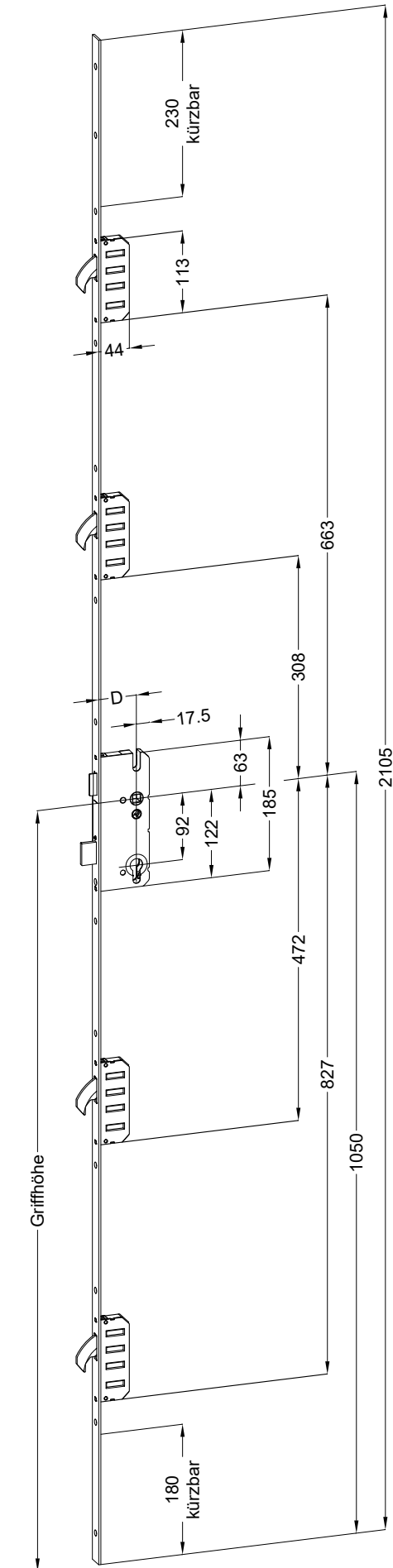

Technische Änderungen vorbehalten!

Schraublage
Schloss: T-F2460 .../D 92/... M4 RS
DIN LS spiegelbildlich

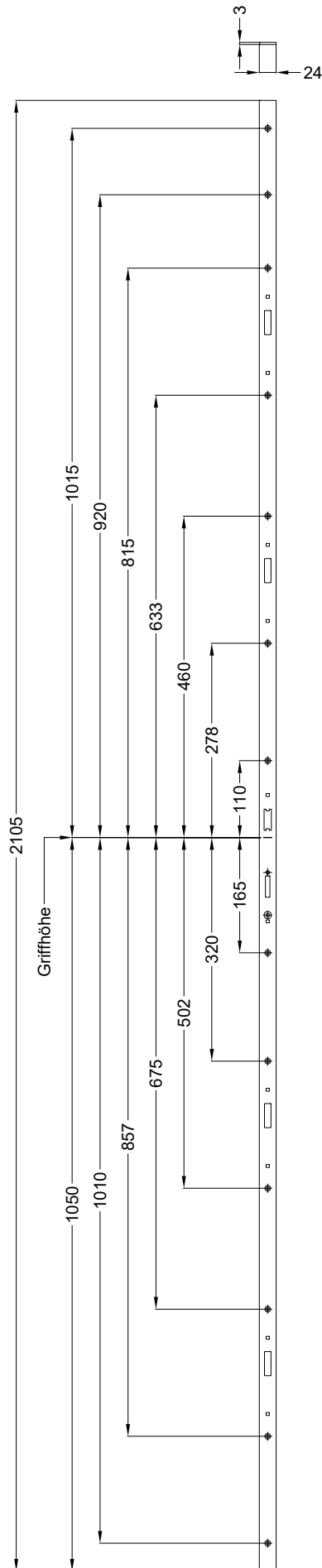

Ansichten

**Schloss: T-F2460 .../D 92/... M4 RS
DIN LS spiegelbildlich**

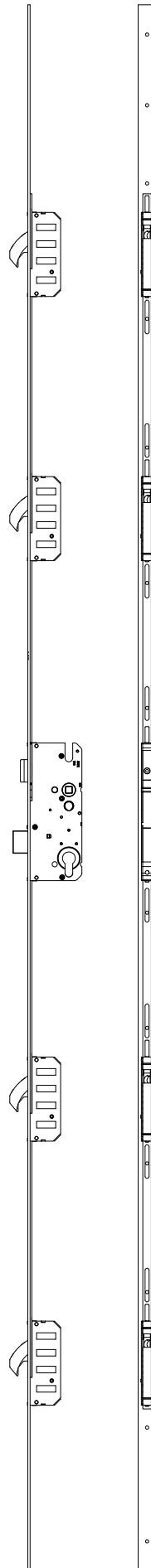

Einbausituationen der Bauteile mit Fräsmaßen

Schloss: T-F2460 .../D 92/... M4 RS

DIN LS spiegelbildlich



Allgemeine Vermaung

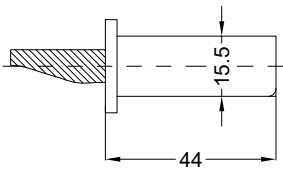

Frsmae

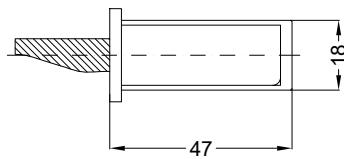

Situation
Schwenkriegel

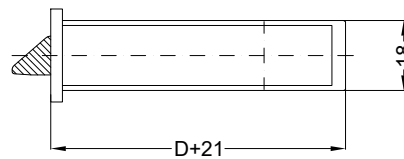
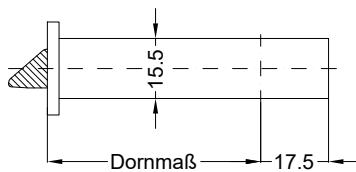

Situation
Falle

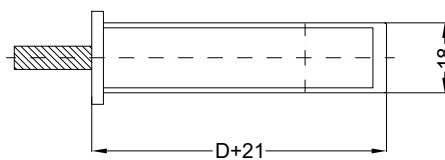
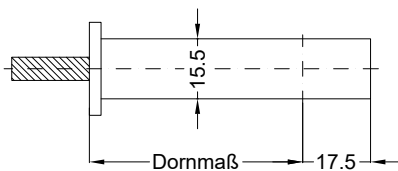

Situation
Riegel

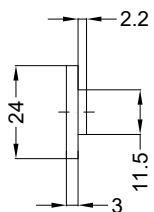

Lage
Schloss

Katalogdarstellung

Schloss: T-F2460 .../D 92/... M4 RS
 DIN LS spiegelbildlich

