

Perspektive  
Schloss: T-F2077 .../D 92/... M2

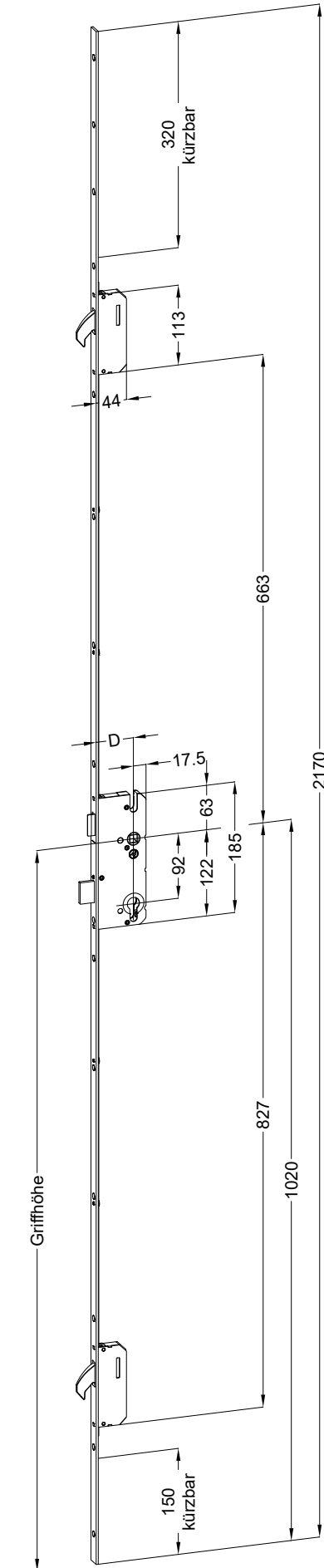

Schraublage  
Schloss: T-F2077 .../D 92/... M2



Technische Änderungen vorbehalten!

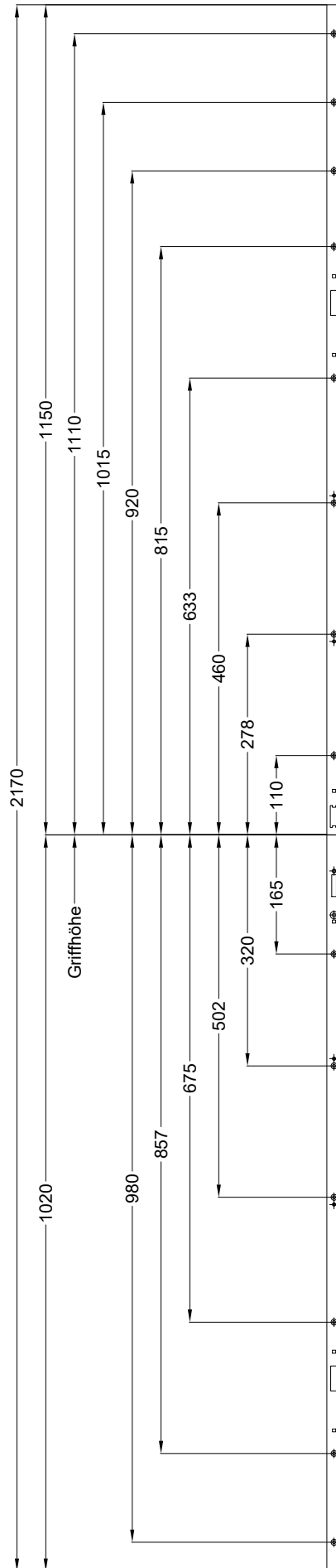

Ansichten

Schloss: T-F2077 .../D 92/... M2

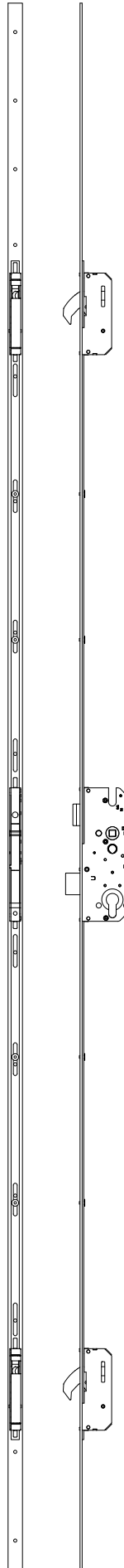

Technische Änderungen vorbehalten!



Allgemeine Vermaung

Frsmae

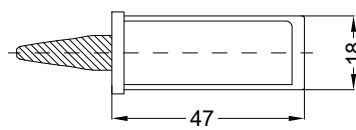
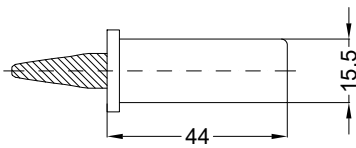

Situation  
 Schwenkriegel

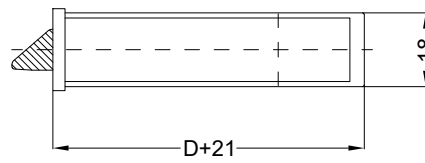
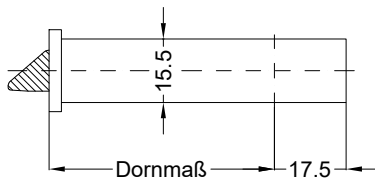

Situation  
 Falle

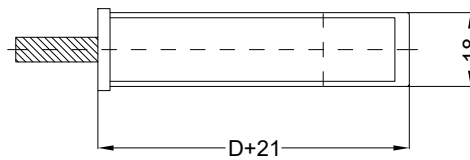
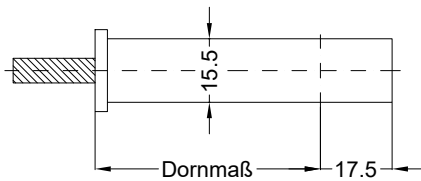

Situation  
 Riegel

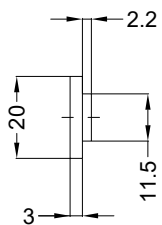

Lage  
 Schloss

