

Perspektive
Schloss:

T-AV3OR FAH2070 .../D A9 92/... M2 RS
DIN LS spiegelbildlich

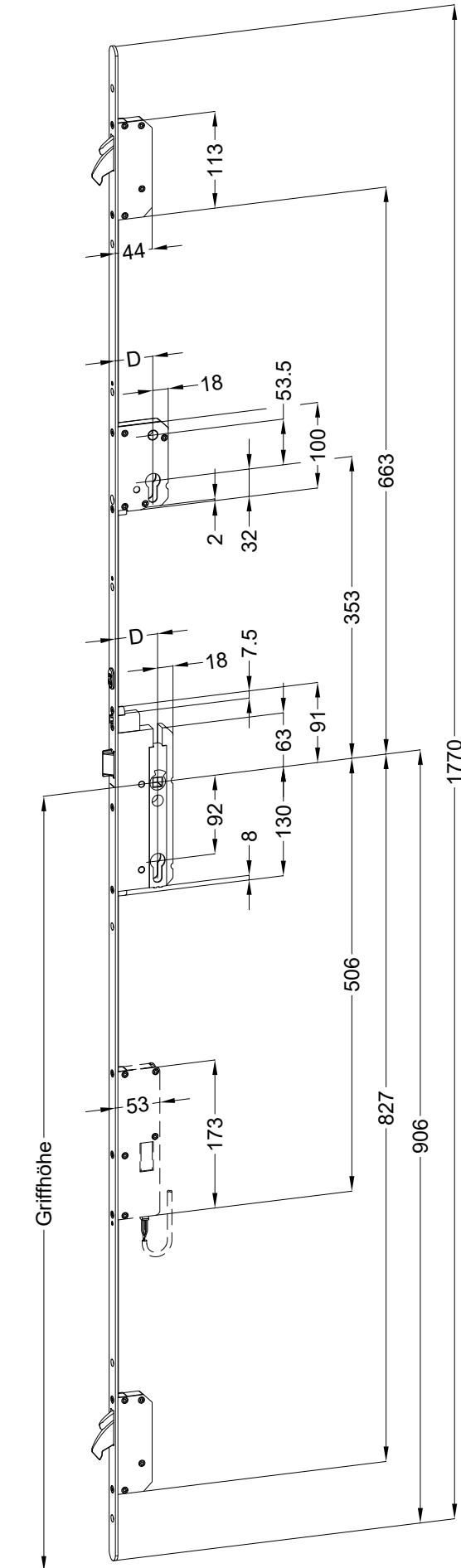

Technische Änderungen vorbehalten!

Schraublage
Schloss:

T-AV3OR FAH2070 .../D A9 92/... M2 RS
DIN LS spiegelbildlich

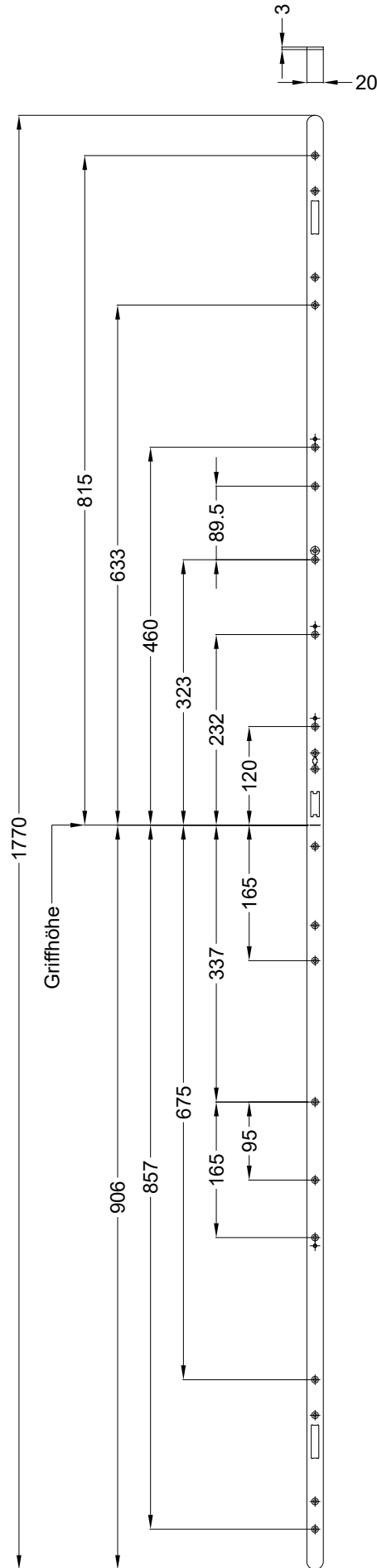

Ansichten
Schloss:

T-AV3OR FAH2070 .../D A9 92/... M2 RS
DIN LS spiegelbildlich

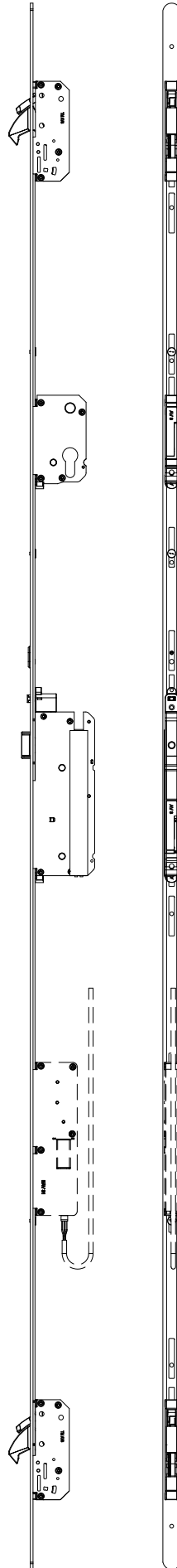

Technische Änderungen vorbehalten!

Empfohlene Fräsung

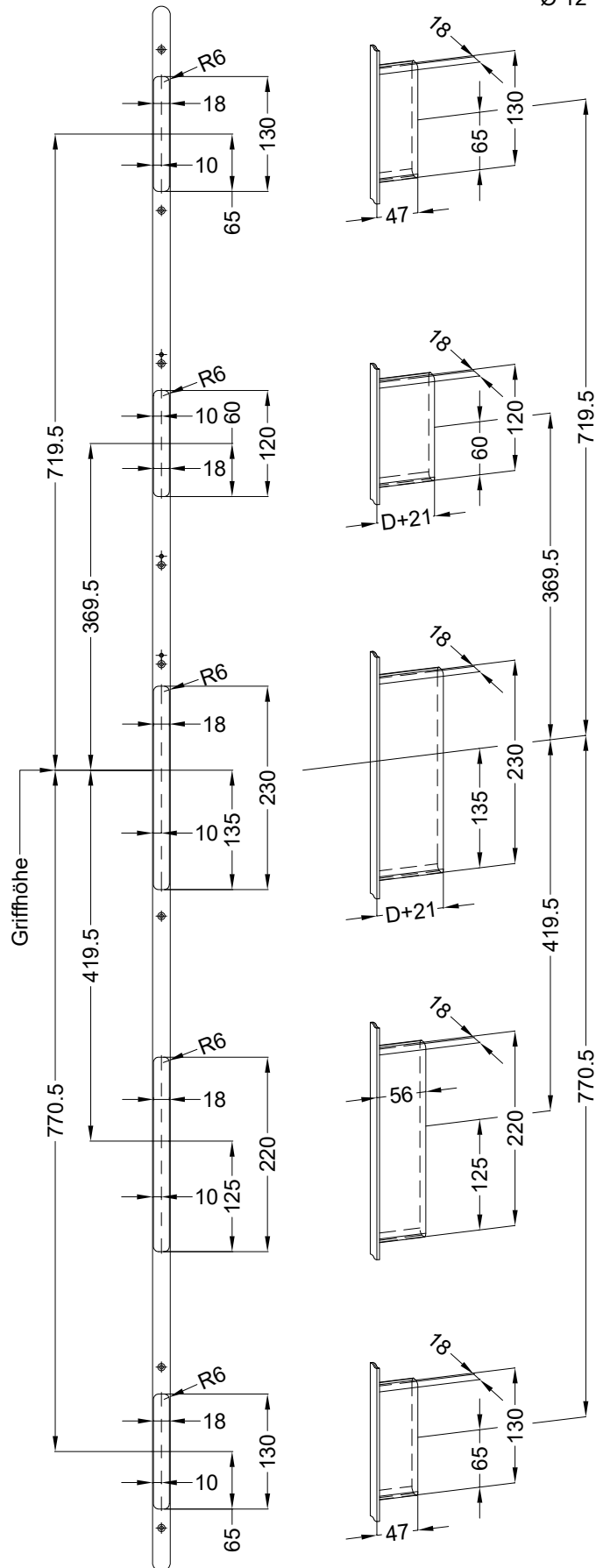
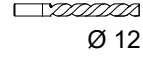

Einbausituationen der Bauteile mit Fräsmaßen

**Schloss: T-AV3OR FAH2070 .../D A9 92/... M2 RS
DIN LS spiegelbildlich**



Allgemeine Vermaung

Frsmae

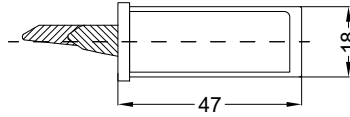
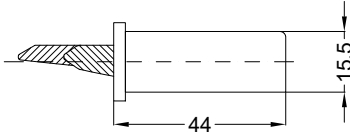

Situation
Schwenkriegel
TM AV3 SK RS

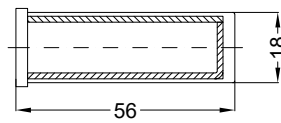
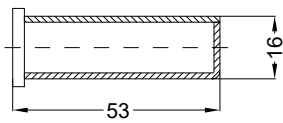

Situation
Motorkasten EAV

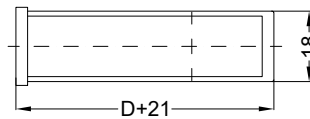
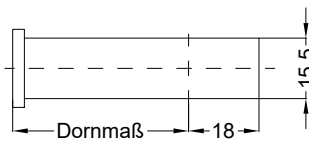

Situation
Gehuse AH Heritage

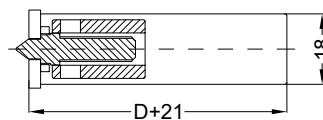
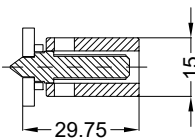

Situation
Taststift
SK AV3

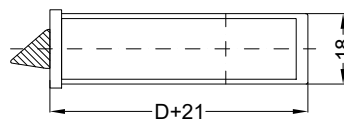
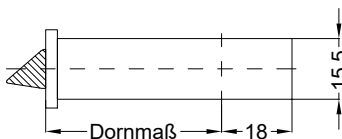

Situation
Falle
SK AV3

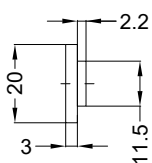

Lage
Schloss

Katalogdarstellung

Schloss:

T-AV3OR FAH2070 .../D A9 92/... M2 RS
DIN LS spiegelbildlich



Empfohlene Fräsung



Ø 12

