

Perspektive
Schloss:

T-FW1677 .../DS 92/... M2

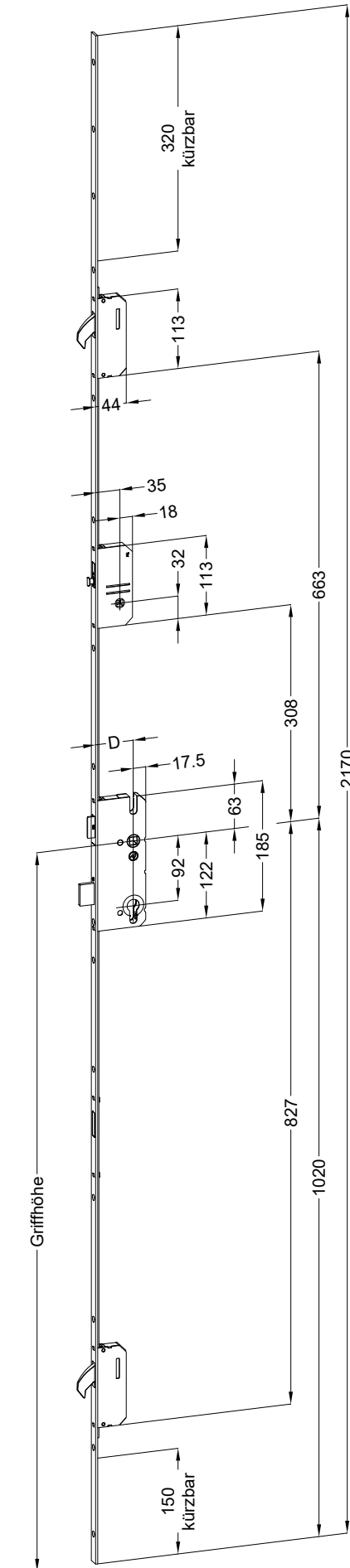

Schraublage
Schloss:

T-FW1677 .../DS 92/... M2

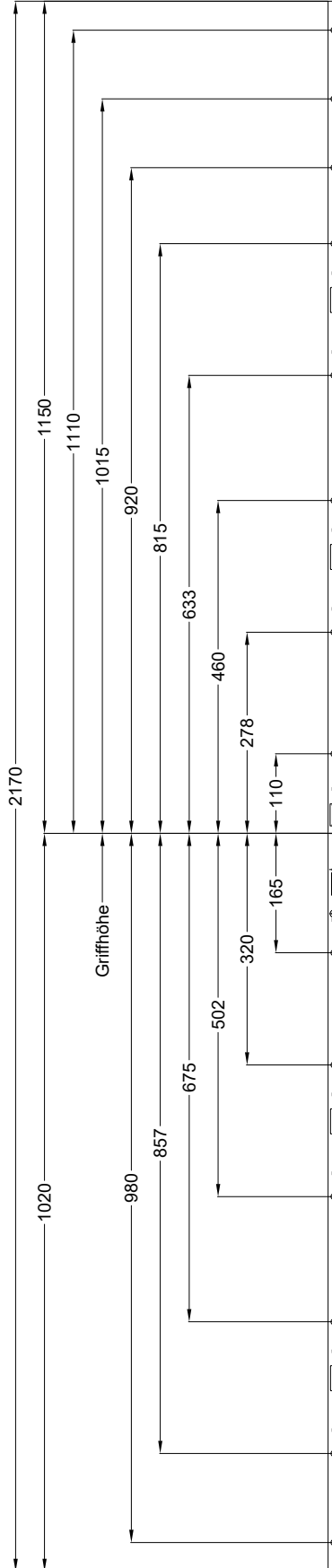
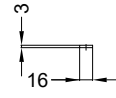

Technische Änderungen vorbehalten!

Ansichten
Schloss:

T-FW1677 .../DS 92/... M2

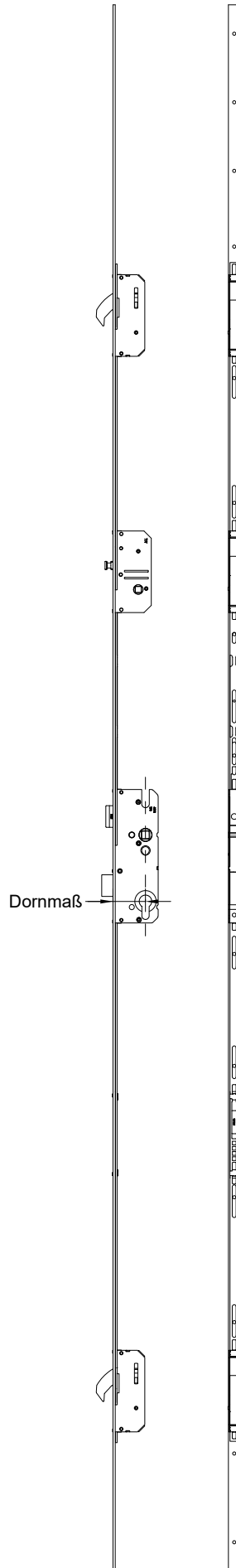

Technische Änderungen vorbehalten!

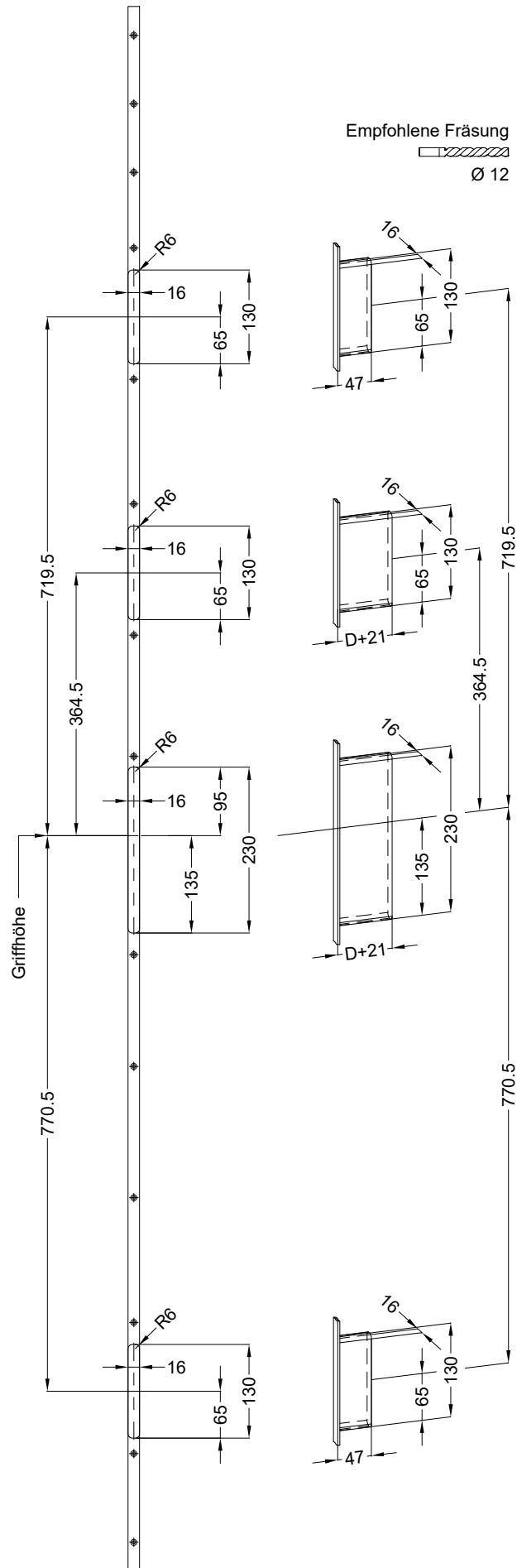

Allgemeine Vermaung

Frsmae

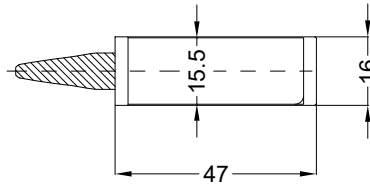
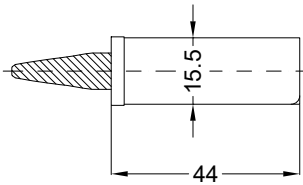

Situation
Schwenkriegel

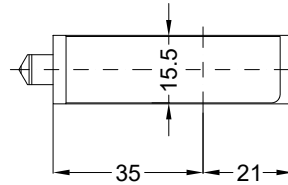
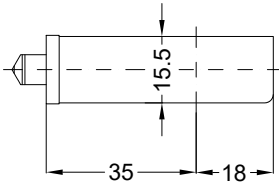

Situation
Trwchter

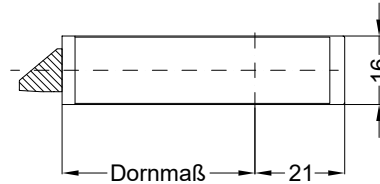
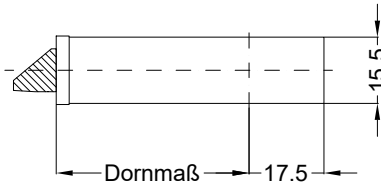

Situation
Falle

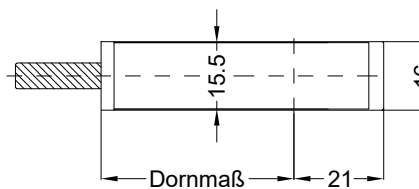
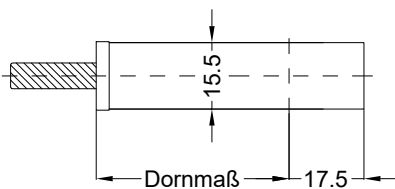

Situation
Riegel

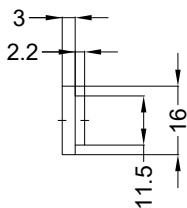

Lage
Schloss

Katalogdarstellung

Schloss: T-FW1677 .../DS 92/... M2

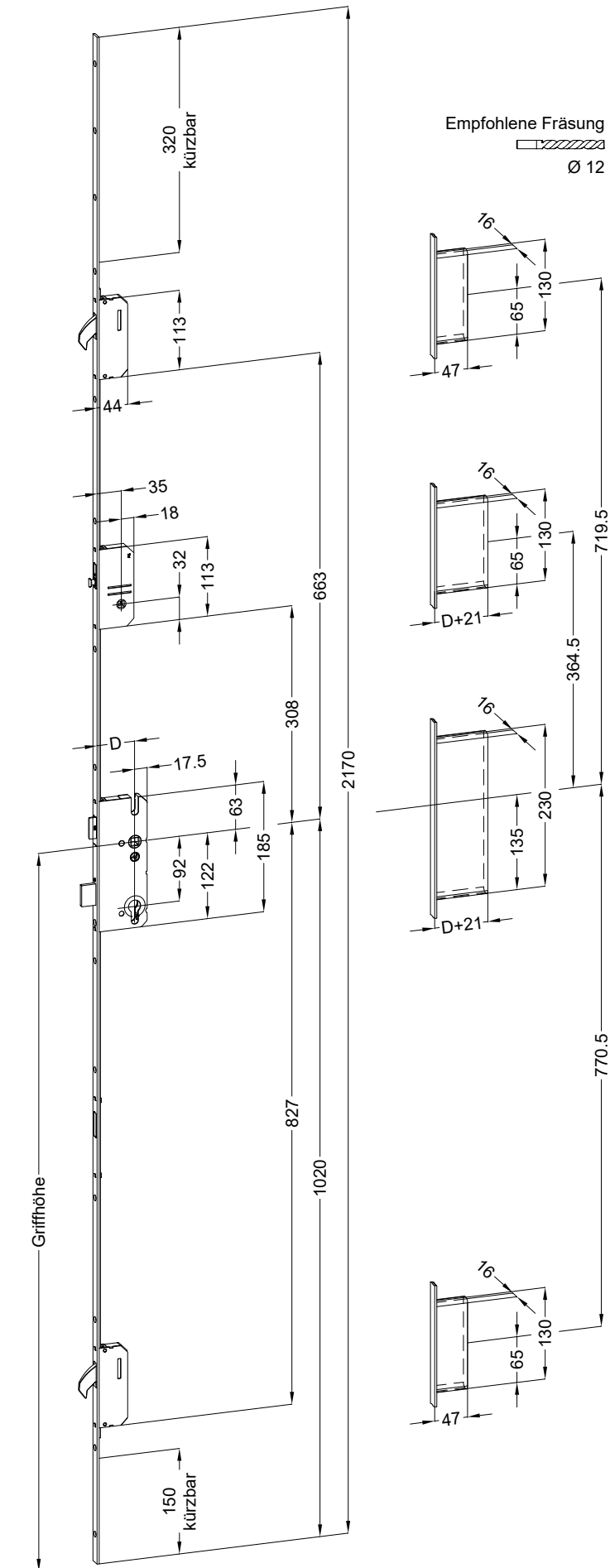

Technische Änderungen vorbehalten!