

Ansichten
Schloss:

STV-F2007 .../D 92/... B2

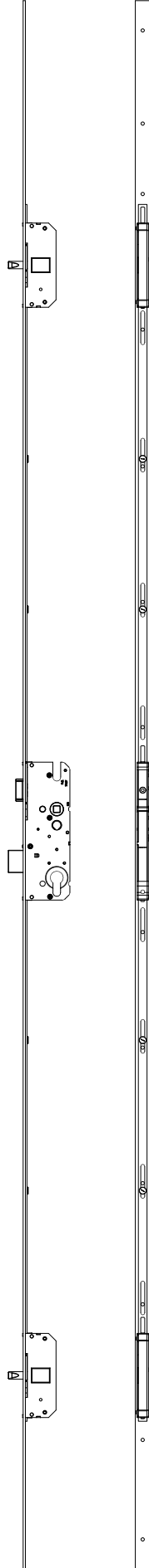

Technische Änderungen vorbehalten!

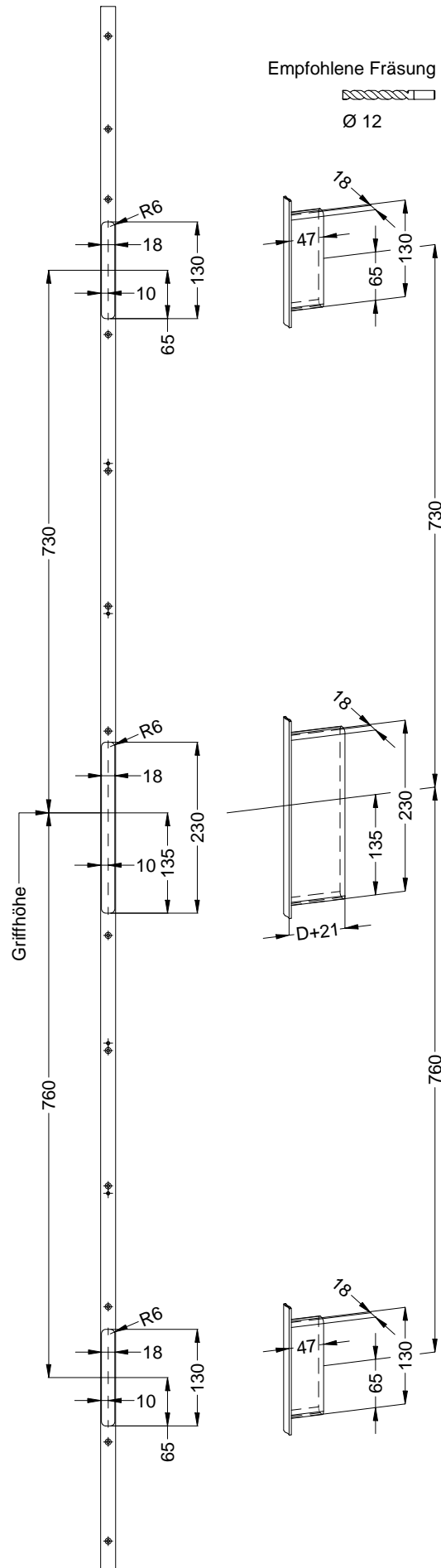

Allgemeine Vermaßung

Fräsmaße

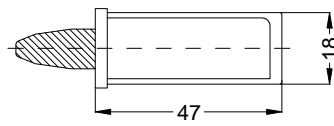
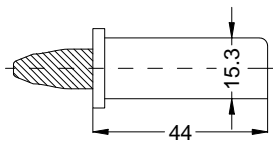

Situation
 Bolzenschloss

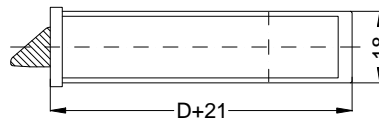
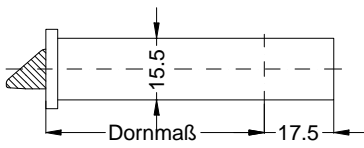

Situation
 Falle

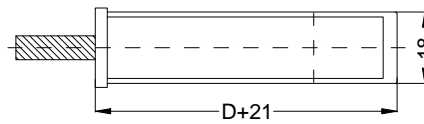
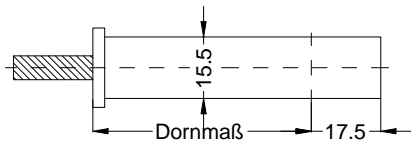

Situation
 Riegel

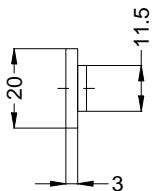

Lage
 Schloss

