

Ansichten

Schloss: T-F2006 .../D 72/... B2

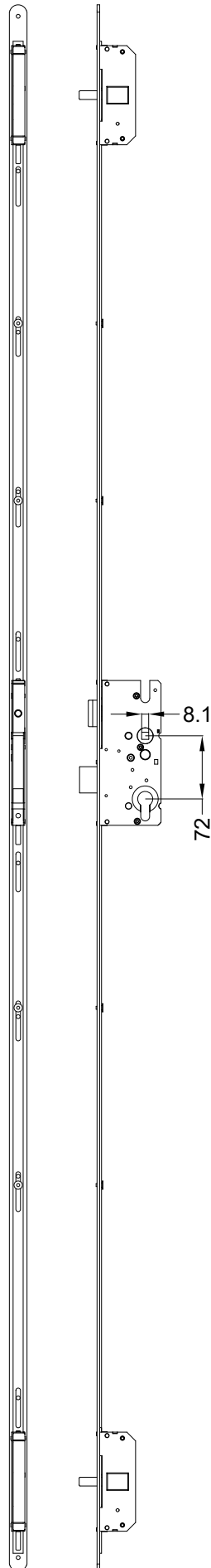

Technische Änderungen vorbehalten!

Fräsmaße
Schloss:

T-F2006 .../D 72/... B2



Empfohlene Fräsung

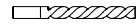

Ø 12

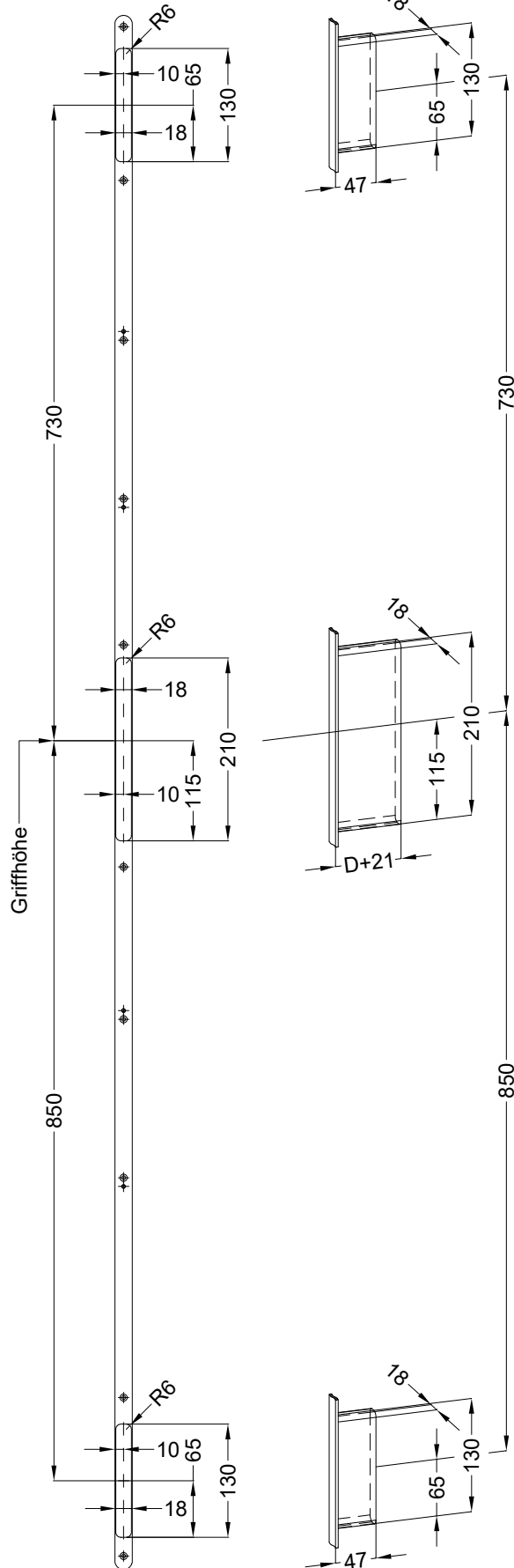

Allgemeine Vermaung

Frsmae

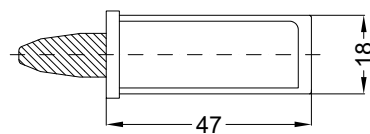
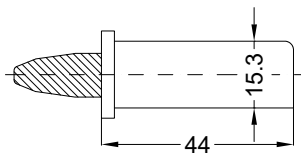

Situation
 Bolzenschloss

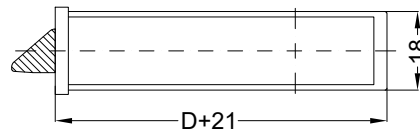
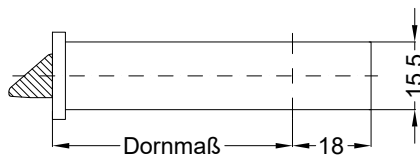

Situation
 Falle

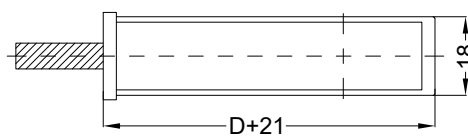
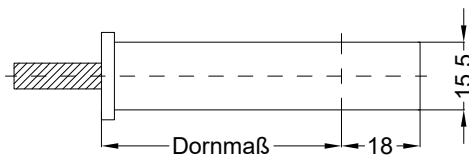

Situation
 Riegel

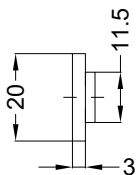

Lage
 Schloss

Katalogdarstellung

Schloss: T-F2006 .../D 72/... B2



Empfohlene Fräsung

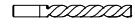

Ø 12

