

Schraublage
Schloss:

T-FGP1660 ... /35S 92/ ... M2 R2

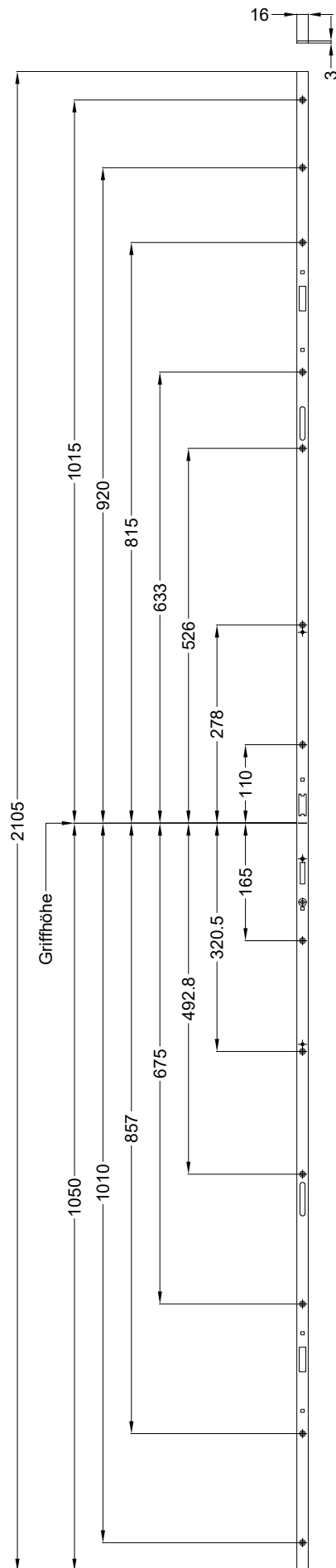

Technische Änderungen vorbehalten!

Ansichten
Schloss:

T-FGP1660 ... /35S 92/ ... M2 R2

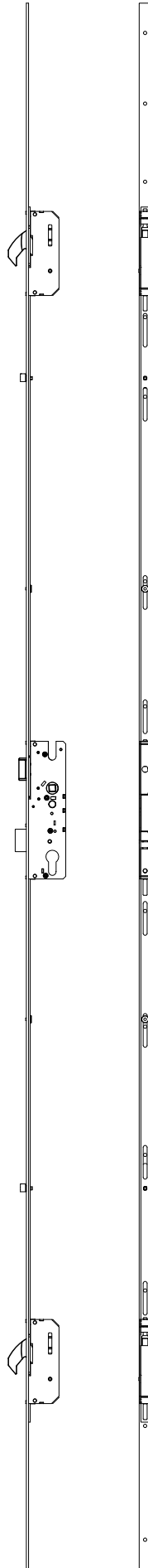

Technische Änderungen vorbehalten!

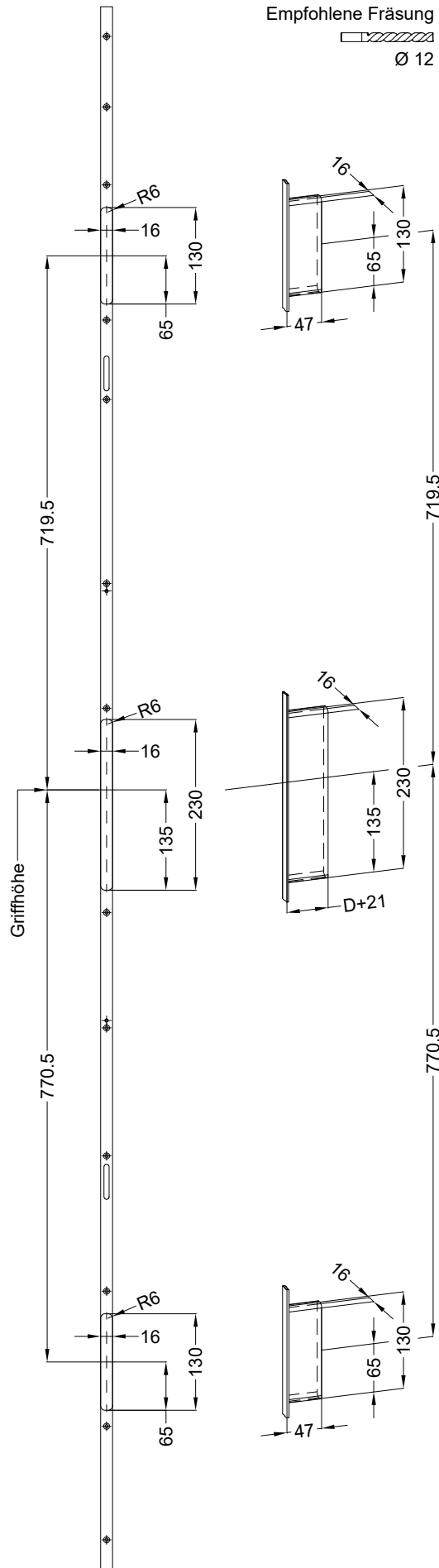

Allgemeine Vermaßung

Fräsmaße

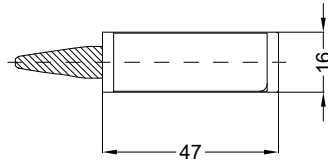
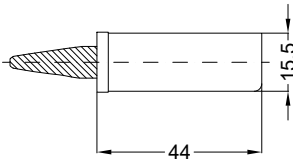

Situation
 Schwenkriegel
 Gehäuse TM6 Y2K BL

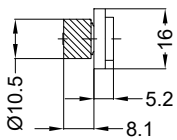

Situation
 Exzentrerschliessbolzen SL

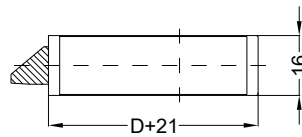
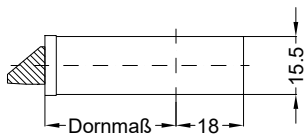

Situation
 Falle
 SK TTP

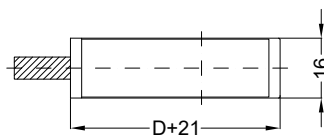
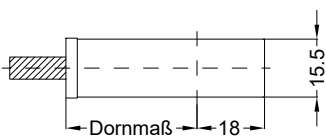

Situation
 Riegel
 SK TTP

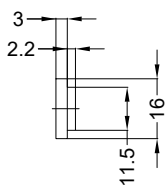

Lage
 Schloss

Technische Änderungen vorbehalten!

