

Perspektive  
Schloss:

T-UW2471 .../D S 92/... M3

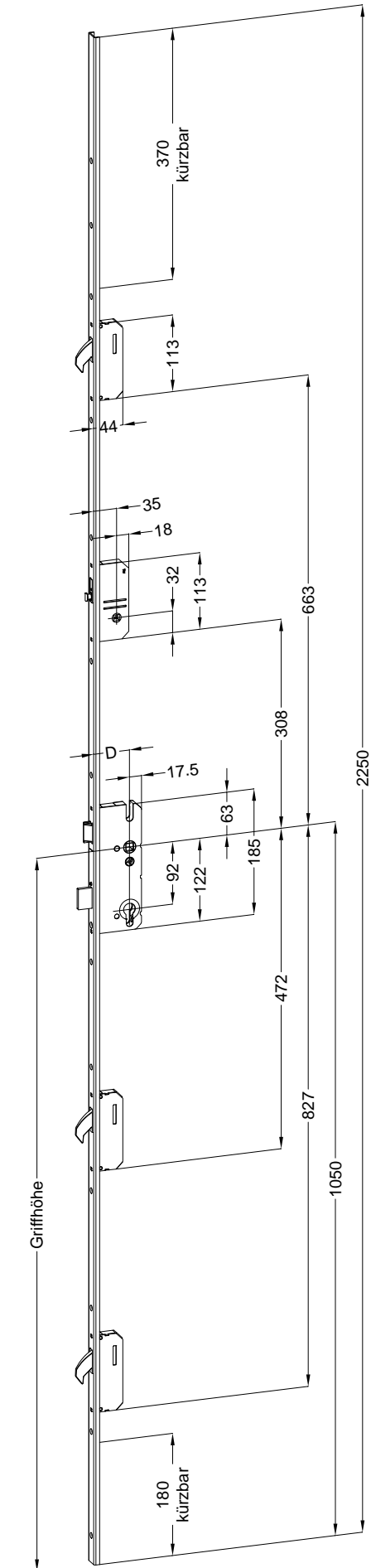

Technische Änderungen vorbehalten!



Schraublage  
Schloss:

T-UW2471 .../D S 92/... M3

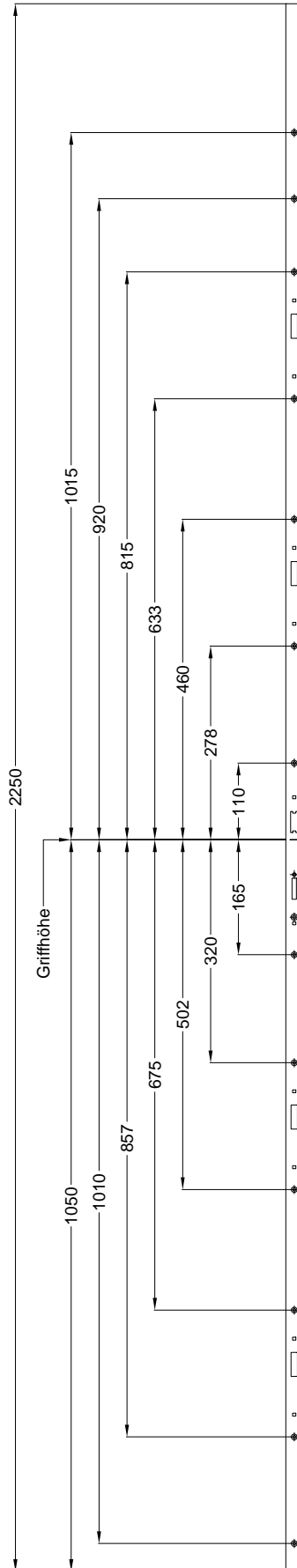
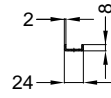

Technische Änderungen vorbehalten!

Ansichten  
Schloss:

T-UW2471 .../D S 92/... M3

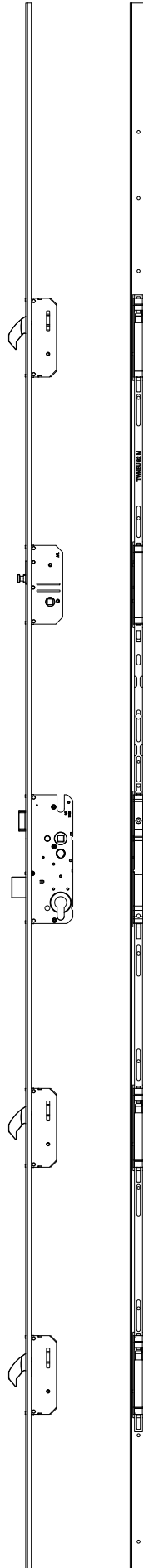

Technische Änderungen vorbehalten!

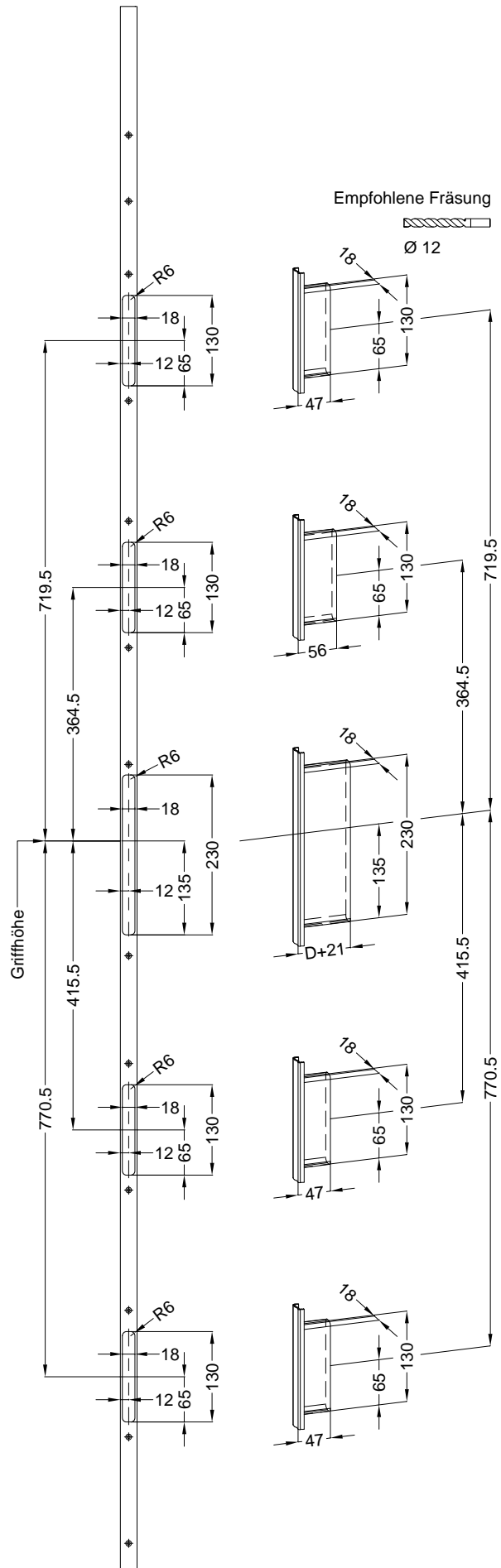

Allgemeine Vermaung

Frsmae

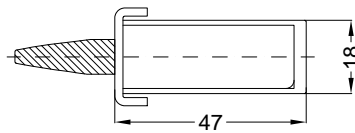
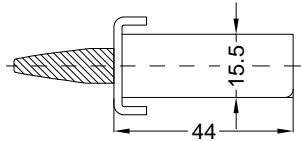

Situation  
 Schwenkriegel

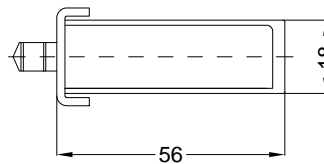
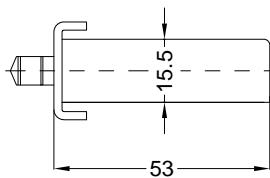

Situation  
 Trwchter

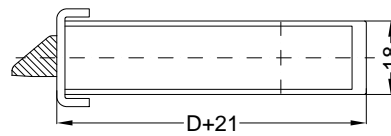
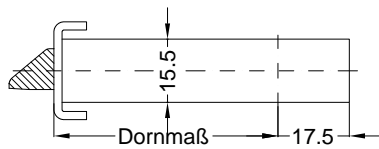

Situation  
 Falle

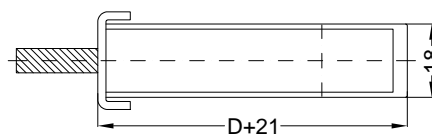
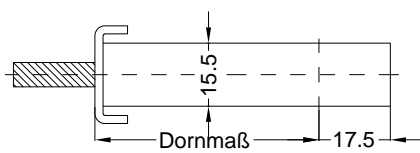

Situation  
 Riegel

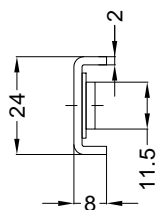

Lage  
 Schloss

