

Perspektive
Schloss:

T-F2060 .../D 92/... M2 RS
DIN LS spiegelbildlich

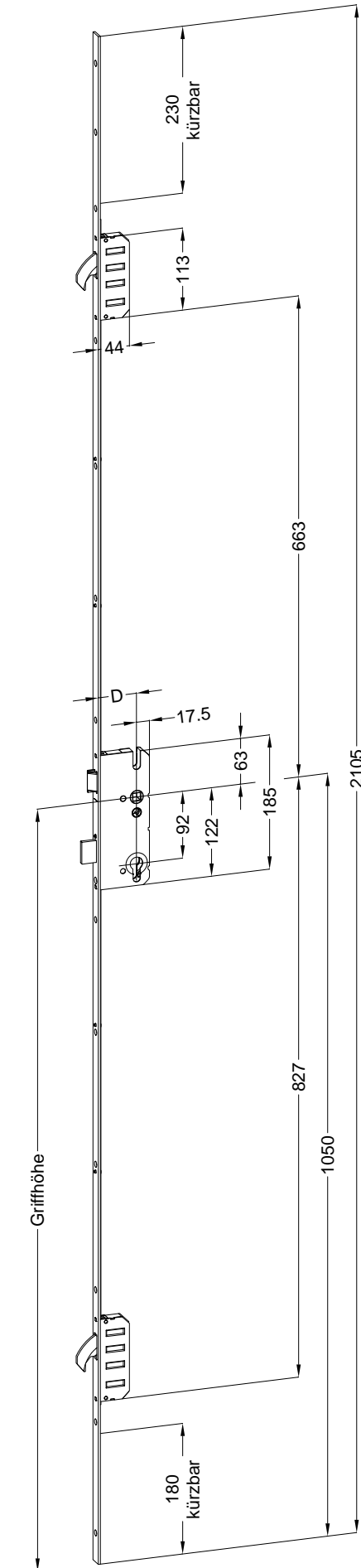

Technische Änderungen vorbehalten!

Schraublage
Schloss:

T-F2060 .../D 92/... M2 RS
DIN LS spiegelbildlich

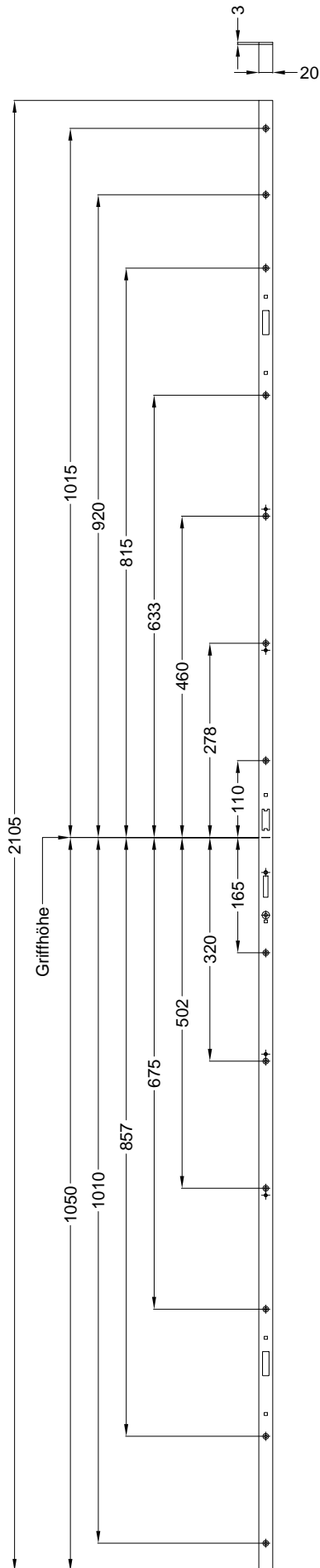

Ansichten
Schloss:

T-F2060 .../D 92/... M2 RS
DIN LS spiegelbildlich

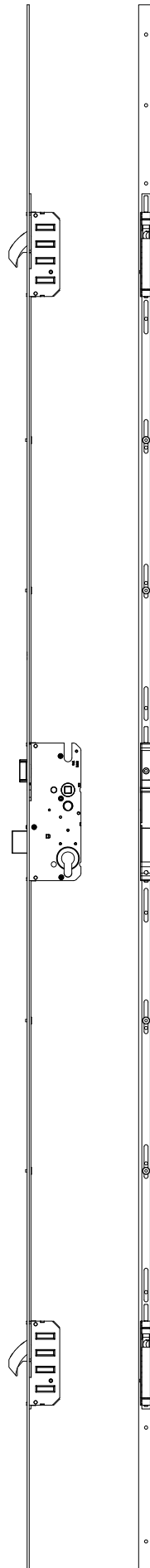

Technische Änderungen vorbehalten!

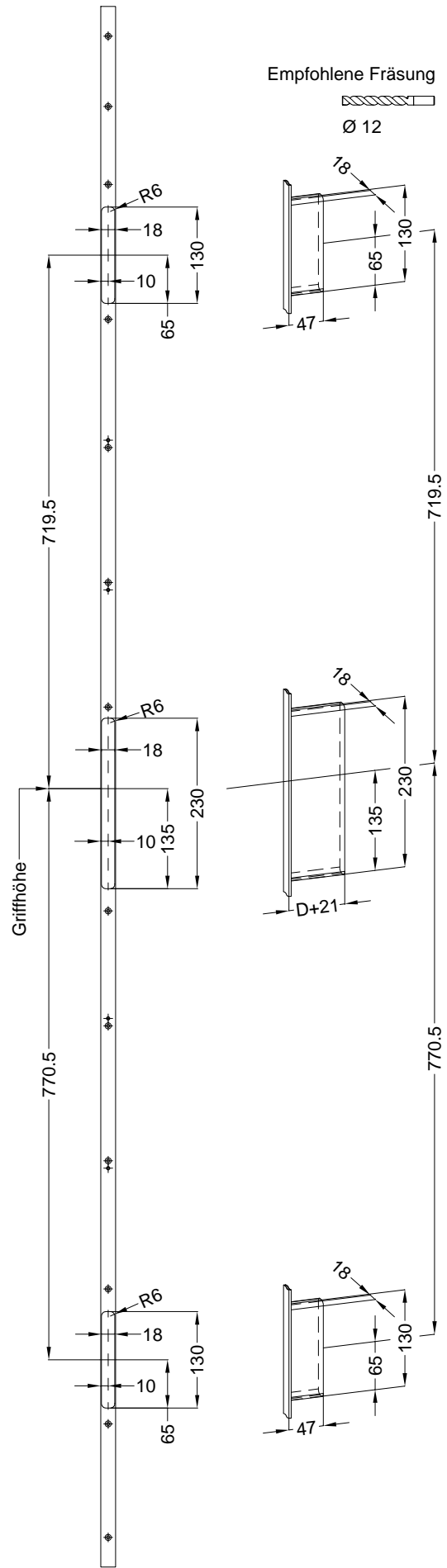

Einbausituationen der Bauteile mit Fräsmaßen

Schloss: T-F2060 .../D 92/... M2 RS
DIN LS spiegelbildlich



Allgemeine Vermaung

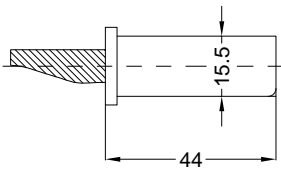

Frsmae

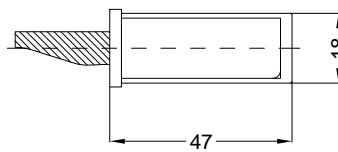

Situation
Schwenkriegel

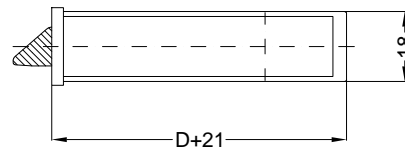
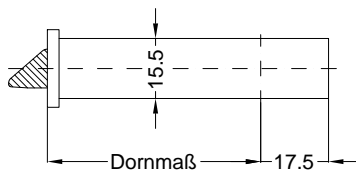

Situation
Falle

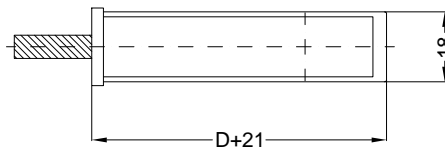
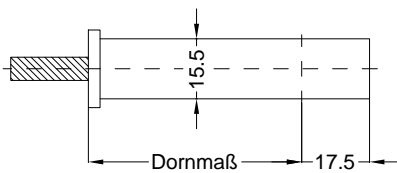

Situation
Riegel

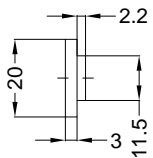

Lage
Schloss

Katalogdarstellung

Schloss: T-F2060 .../D 92/... M2 RS
DIN LS spiegelbildlich

