

Perspektive
Schloss:

T-U24185 .../D 92/... M2 RS
DIN LS spiegelbildlich

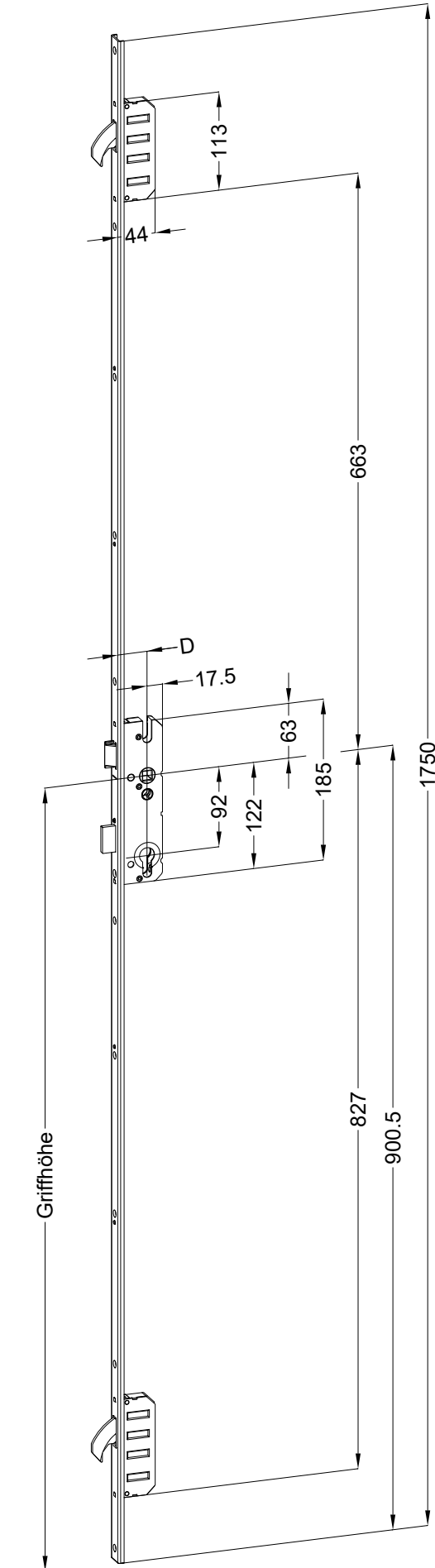

Technische Änderungen vorbehalten!

Schraublage
Schloss:

T-U24185 .../D 92/... M2 RS
DIN LS spiegelbildlich

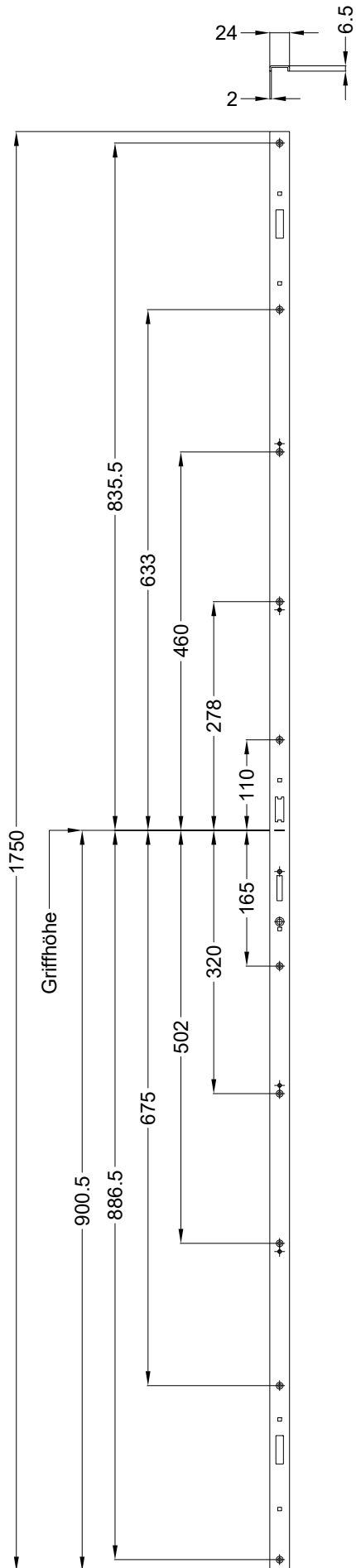

Ansichten
Schloss:

T-U24185 .../D 92/... M2 RS
DIN LS spiegelbildlich

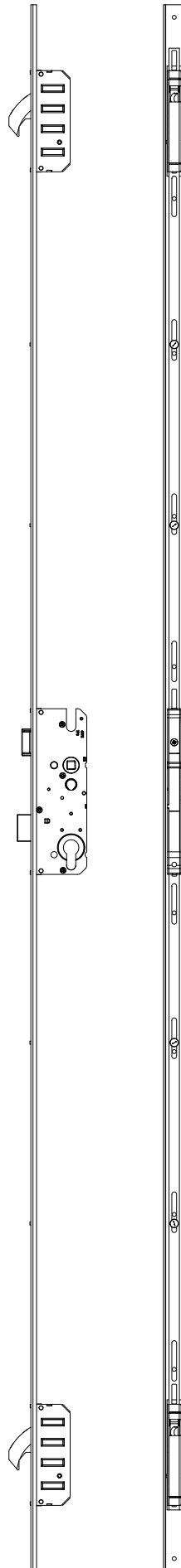

Technische Änderungen vorbehalten!

Fräsmaße
Schloss:

T-U24185 .../D 92/... M2 RS
DIN LS spiegelbildlich



Empfohlene Fräsung

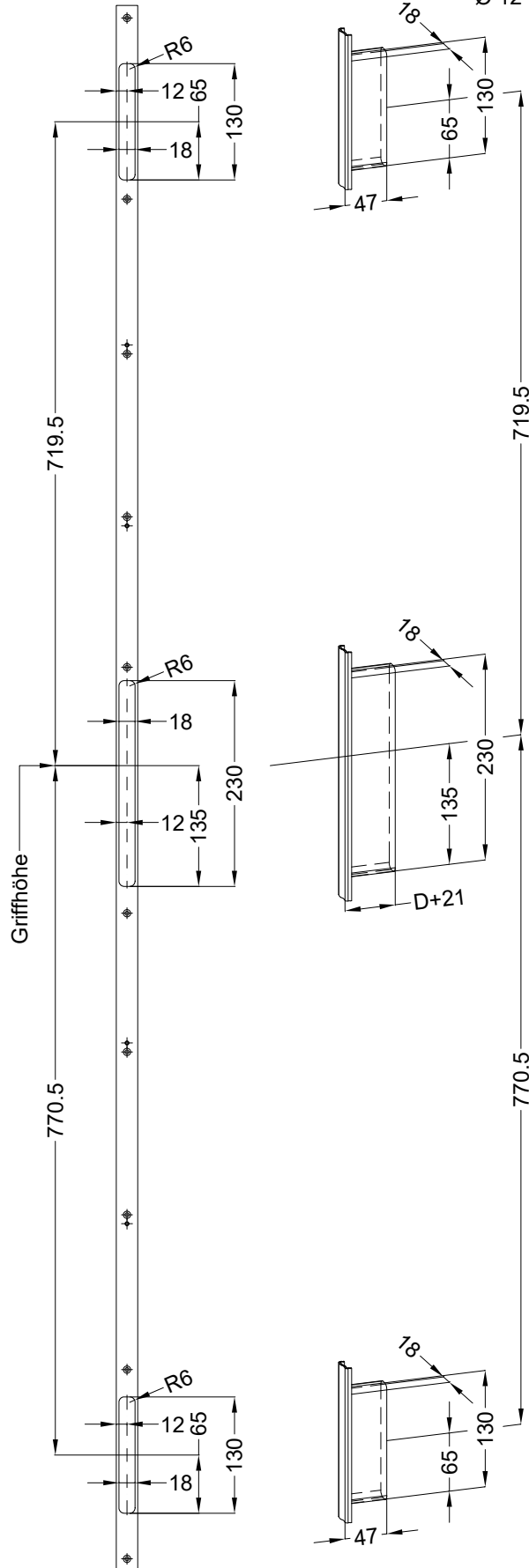
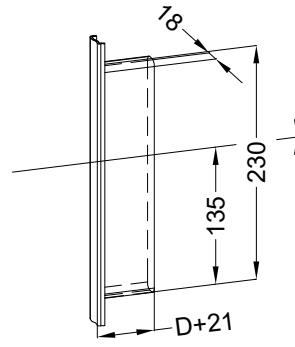
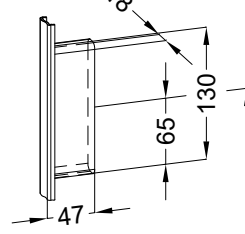
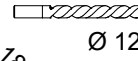

Technische Änderungen vorbehalten!

Einbausituationen der Bauteile mit Fräsmaßen
Schloss: T-U24185 .../D 92/... M2 RS
DIN LS spiegelbildlich



Allgemeine Vermaung

Frsmae

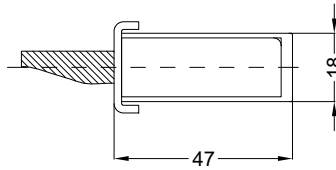
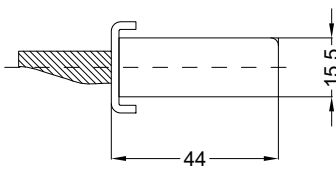

Situation
 Schwenkriegel
 G1 Gehuse TS1

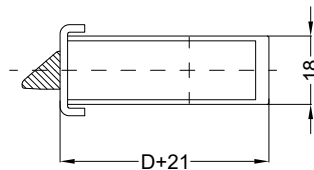
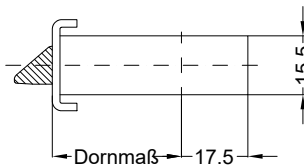

Situation
 Falle
 SK TP3

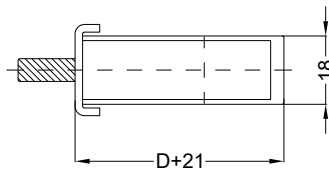
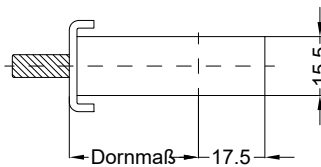

Situation
 Riegel
 SK TP3

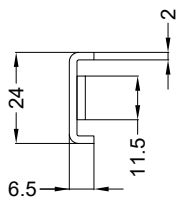

Lage
 Schloss

Katalogdarstellung

Schloss: T-U24185 .../D 92/... M2 RS
DIN LS spiegelbildlich

