

Perspektive
Schloss:

T AV3-FAO2060 .../D A9 92/... M2 RS
DIN LS spiegelbildlich

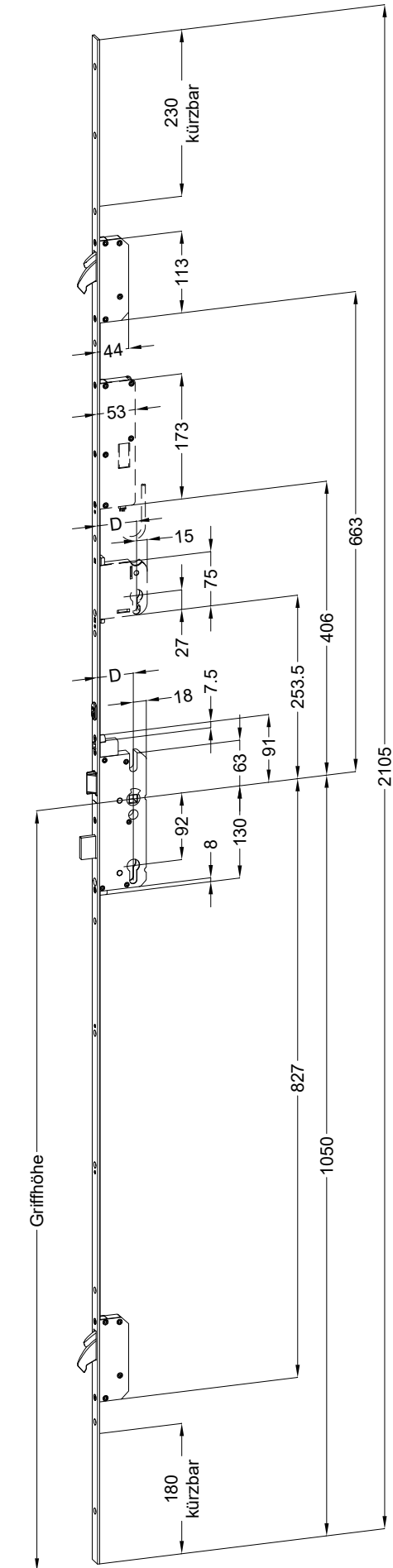

Technische Änderungen vorbehalten!

Schraublage
Schloss:

T AV3-FAO2060 .../D A9 92/... M2 RS
DIN LS spiegelbildlich

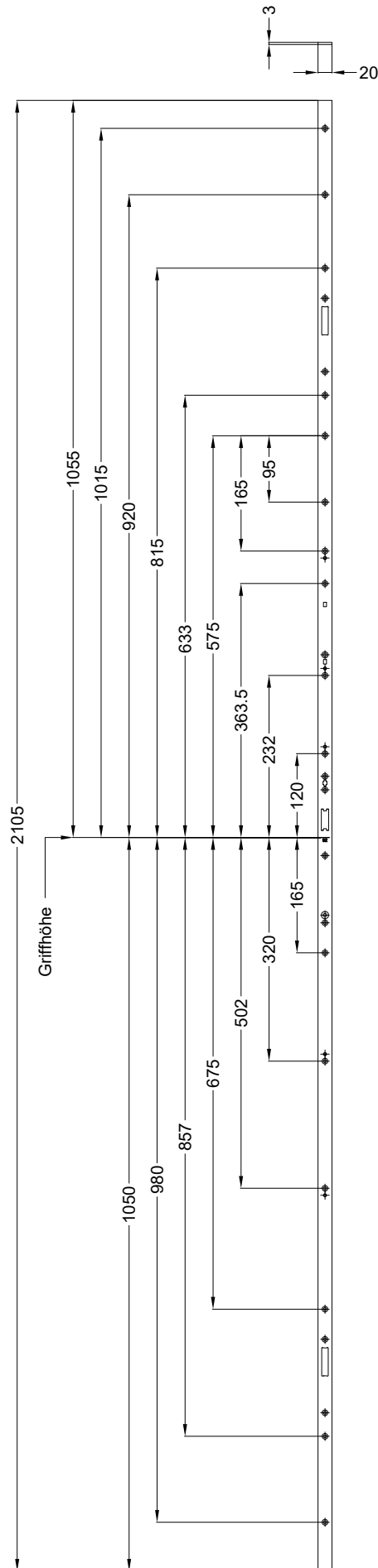

Technische Änderungen vorbehalten!

Ansichten
Schloss:

T AV3-FAO2060 .../D A9 92/... M2 RS
DIN LS spiegelbildlich

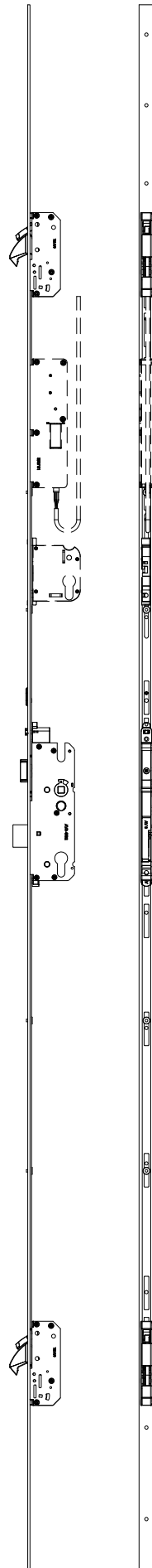

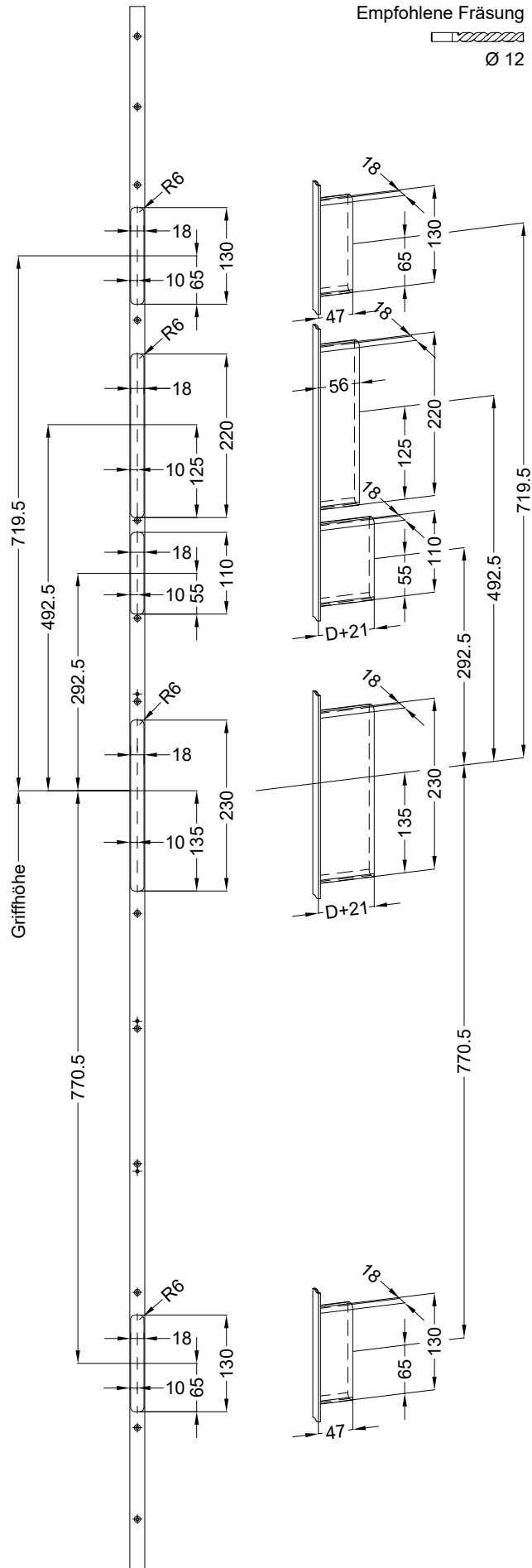

Einbausituationen der Bauteile mit Fräsmaßen

**Schloss: T AV3-FAO2060 .../D A9 92/... M2 RS
DIN LS spiegelbildlich**



Allgemeine Vermaung

Frsmae

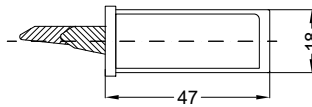
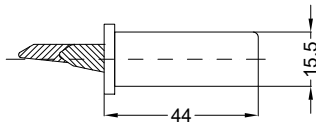

Situation
Schwenkriegel
TM AV3 SK RS

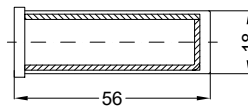
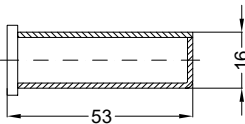

Situation
Motorkasten EAV

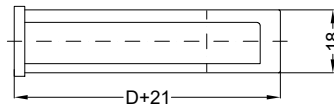
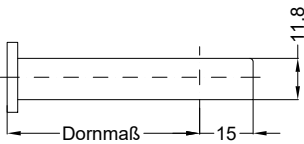

Situation
Zusatzschloss FA

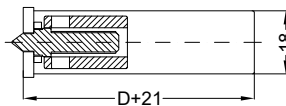
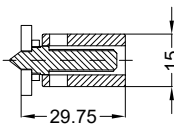

Situation
Taststift
SK AV3

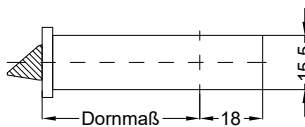

Situation
Falle
SK AV3

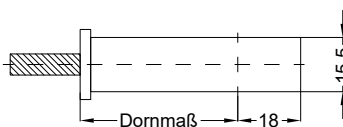

Situation
Riegel
SK AV3

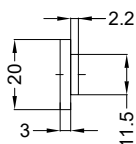

Lage
Schloss

Katalogdarstellung

Schloss:

T AV3-FAO2060 .../D A9 92/... M2 RS
DIN LS spiegelbildlich

