

Technische Daten / Technical data

- Spannung / Voltage: 24 V DC
- Stromaufnahme / Current draw: 50 mA
- Leitungslänge, max. / Wire length, max.: 100 m
- Schutzart / Protection rating: IP 40
- Lagerung / Storage: -20 °C ... 85 °C
keine Betauung / no condensation
- Umgebungstemperatur im Betrieb /
Temperature range during operation: -15 °C ... 50 °C
- EMV Störfestigkeit nach /
EMC protection according to: EN 61000-6-2

Maßzeichnungen / Dimensional drawings

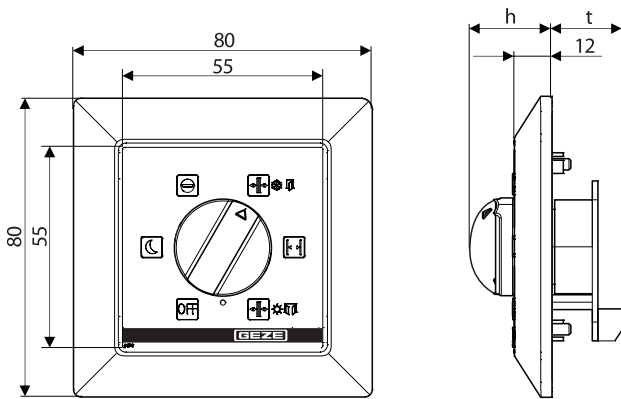

Zusammenbau / Assembly

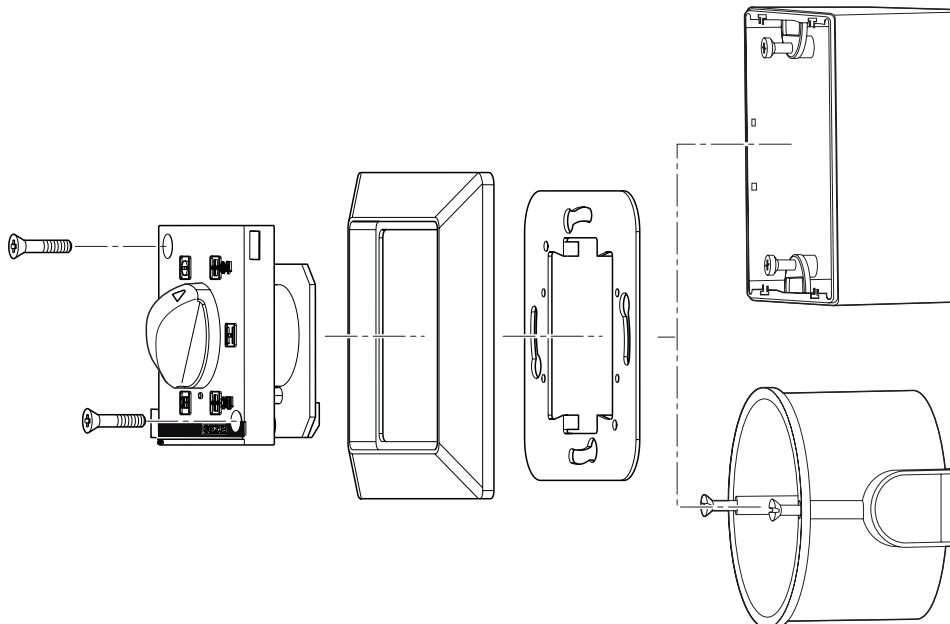

Schablone für Pfostenmontage / Template for installation on a post



Die Papierschablone kann sich abhängig von der Luftfeuchtigkeit maßlich verändern. Verbindlich sind daher nur die Maßangaben.

► Vor der Verwendung Papierschablone maßlich kontrollieren und ggf. korrigieren.

The dimensions of the paper template can change depending on air humidity. For this reason, only our dimensional specifications are applicable.

► Before using the paper template check the dimensions and correct if necessary.

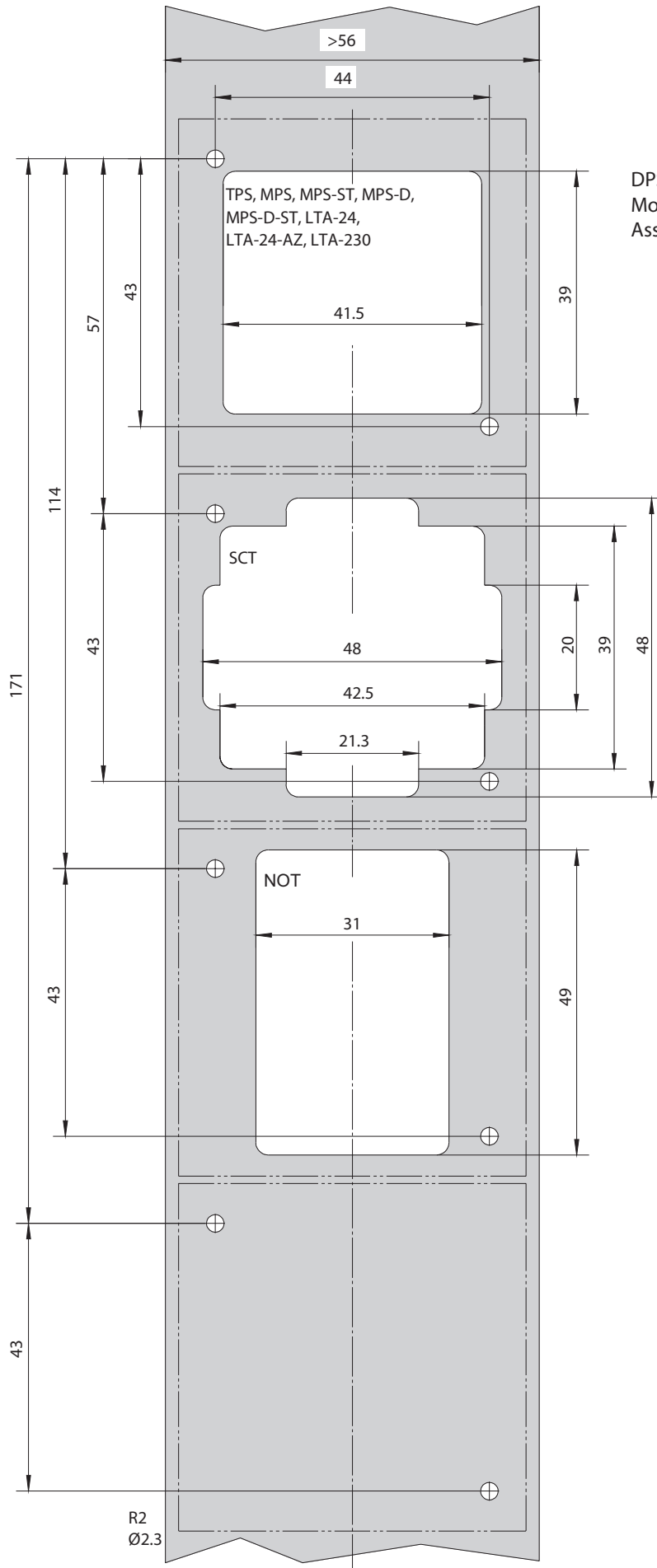

DPS, LTA-LSA:
Montage in Pfosten nicht möglich. /
Assembly on a post not possible.

Schaltpläne / Circuit diagrams

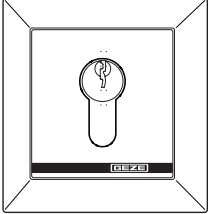
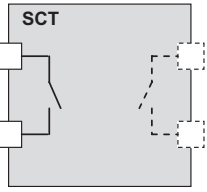
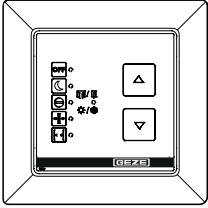
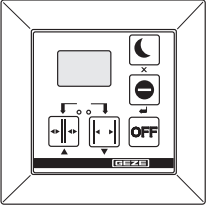
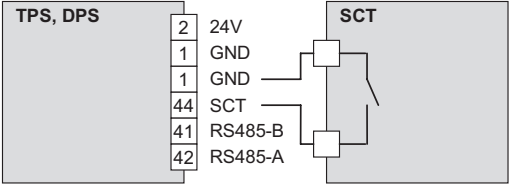
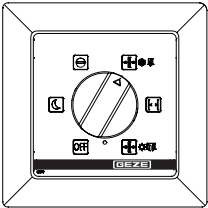
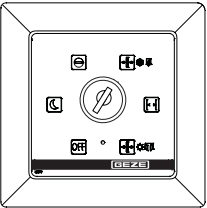
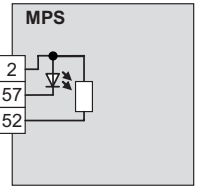
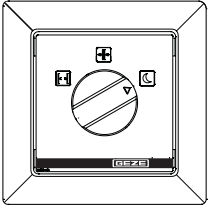
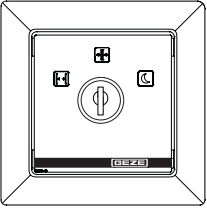
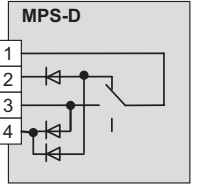
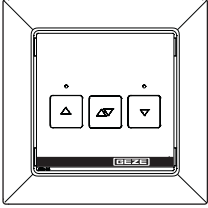
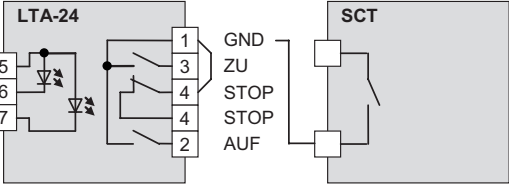
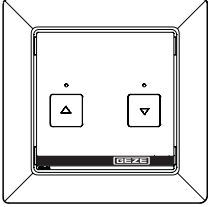
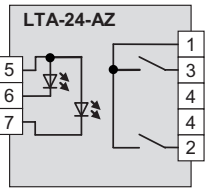
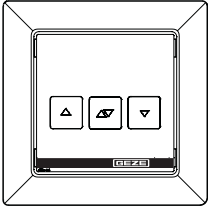
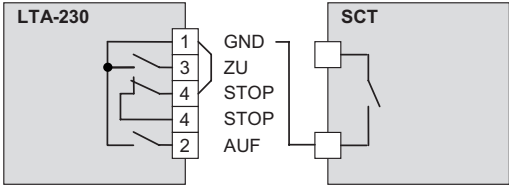
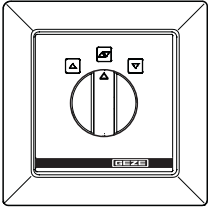
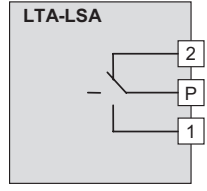
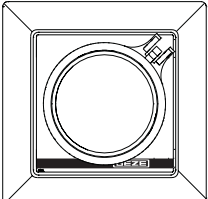
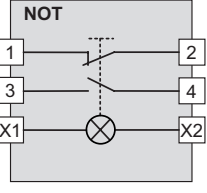
Taster / Switches	Bezeichnung / Description	Mat. Nr. / Mat.No.	Taster / Switches	Bezeichnung / Description	Mat. Nr. / Mat. No.	Schaltplan / Circuit diagram	h [mm]	t [mm]
	SCT (1-pol.)	117996		-	-		11	31.9
	TPS TPS-SCT TPS-KDT TPS-KDT-SCT DPS mit/with OFF DPS ohne/ without OFF DPS mit/with OFF SCT	113231 113232 126582 126583 151524 155809 155810		TPS, DPS			11.3	5.3 31.9
	MPS	113226		MPS-ST	113227		24	36
	MPS-D	118417		MPS-D-ST	118418		24	36
	LTA-24 LTA-24-SCT	118473 127176		LTA-24			11	26
	LTA-24-AZ	129393		LTA-24-AZ			11	26
	LTA-230 LTA-230-SCT	118474 118475		LTA-230			11	26
	LTA-LSA	118476		LTA-LSA			24	32
	NOT	123132		NOT			54	56