

Perspektive
Schloss: T-F 1669/D... 92/... M3 K

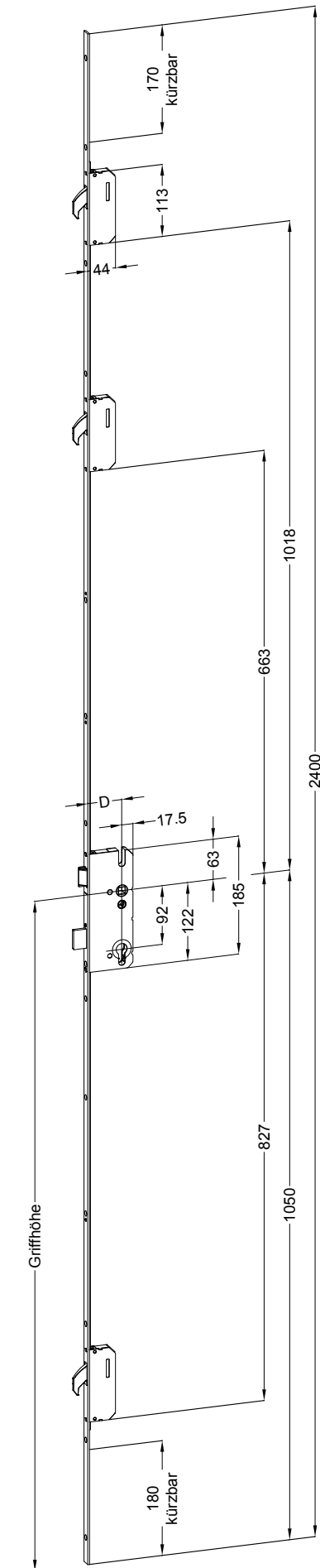

Technische Änderungen vorbehalten!



Schraublage
Schloss: T-F 1669/D... 92/... M3 K



Technische Änderungen vorbehalten!

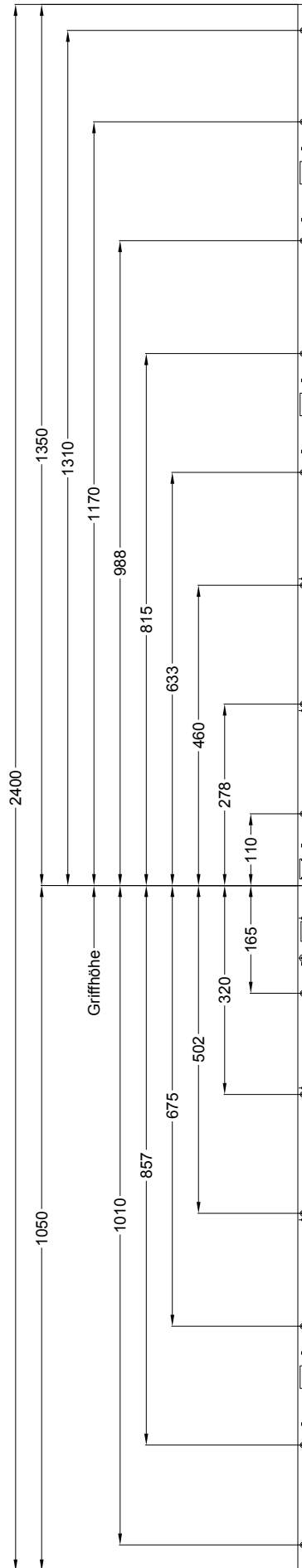

Ansichten

Schloss: T-F 1669/D... 92/... M3 K

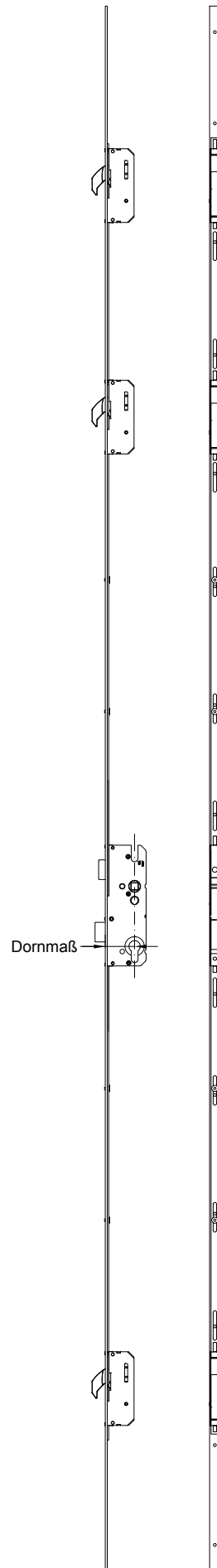

Technische Änderungen vorbehalten!

Allgemeine Vermaung

Frsmae

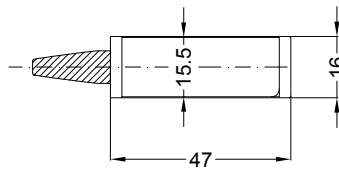
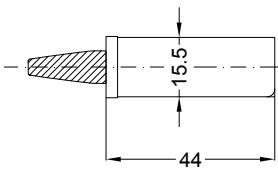

Situation
 Schwenkriegel
 TM6-20

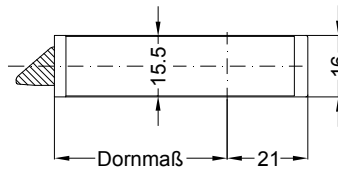
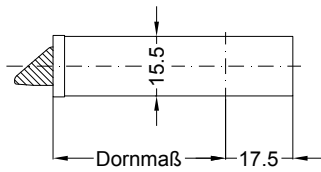

Situation
 Falle

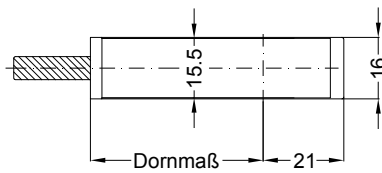
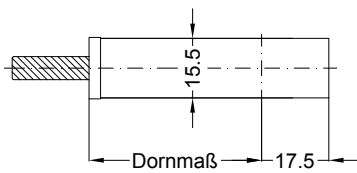

Situation
 Riegel

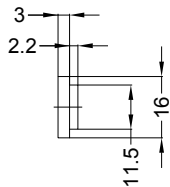

Lage
 Schloss

Katalogdarstellung
 Schloss: T-F 1669/D... 92/... M3 K



Technische Änderungen vorbehalten!

