

Perspektive

Schloss: T-F2077 .../DS 92A/... M2 RS

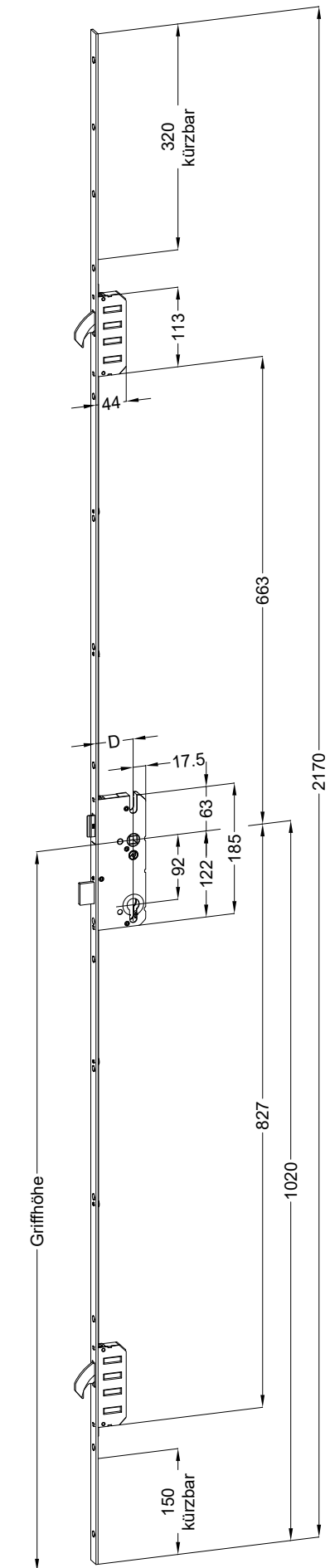

Technische Änderungen vorbehalten!

Schraublage
Schloss: T-F2077 .../DS 92A/... M2 RS

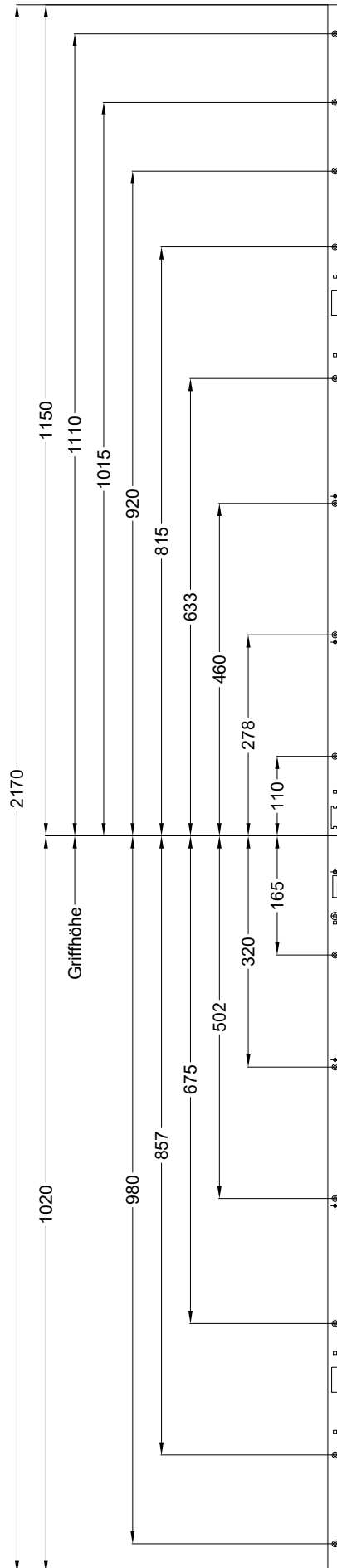

Ansichten

Schloss: T-F2077 .../DS 92A/... M2 RS

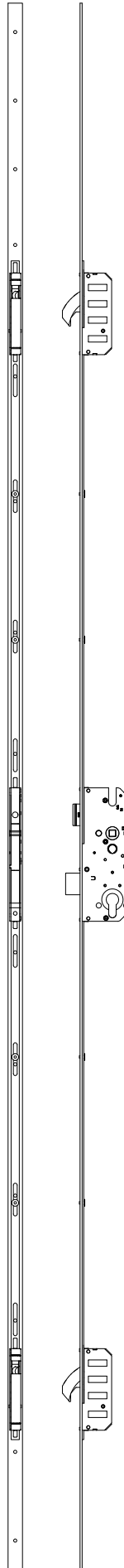

Technische Änderungen vorbehalten!

Allgemeine Vermaung

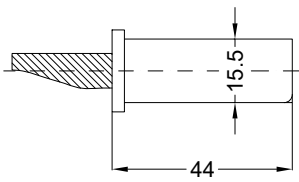

Frsmae

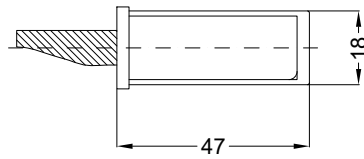

Situation
 Schwenkriegel

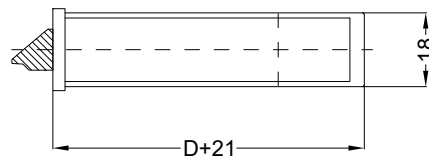
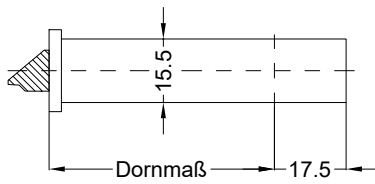

Situation
 Falle SAK

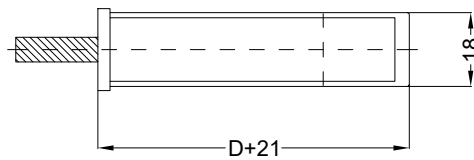
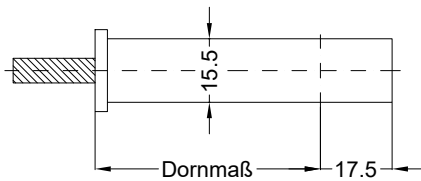

Situation
 Riegel

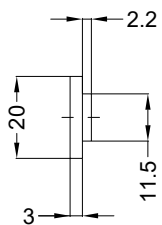

Lage
 Schloss

