

Perspektive

Schloss: T-AP4 E/B/D1 F1660 .../DS 94/9 KABA M2

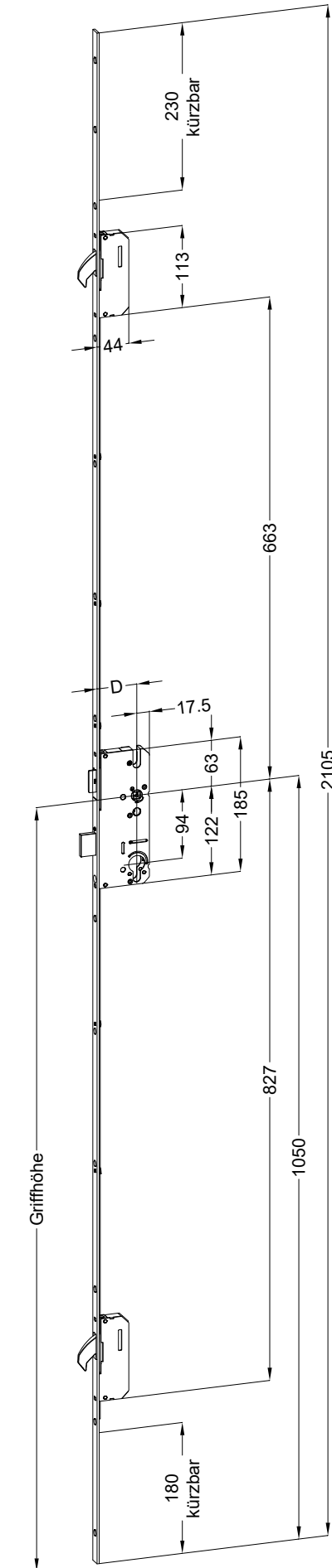

Technische Änderungen vorbehalten!

Schraublage
Schloss: T-AP4 E/B/D1 F1660 .../DS 94/9 KABA M2

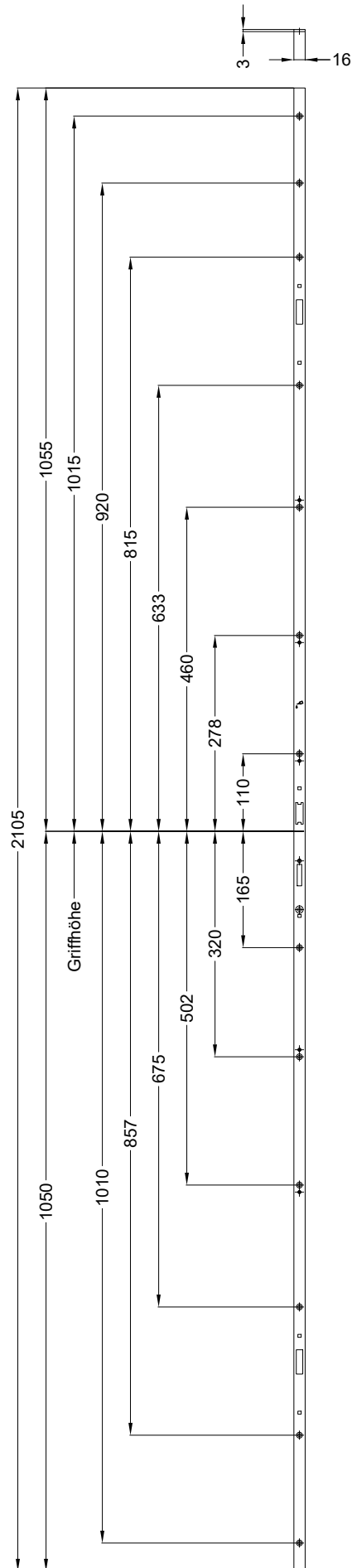

Ansichten

Schloss: T-AP4 E/B/D1 F1660 .../DS 94/9 KABA M2

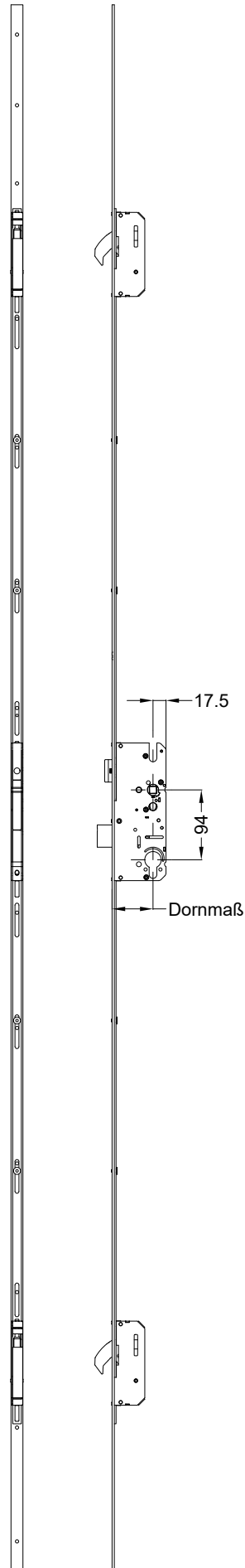

Allgemeine Vermaung

Frsmae

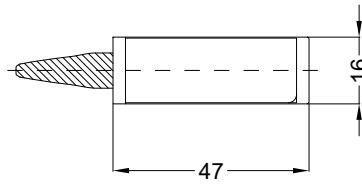
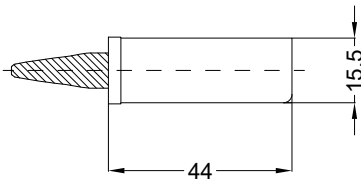

Situation
Schwenkriegel

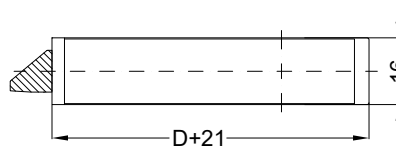
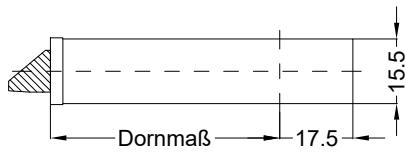

Situation
Falle

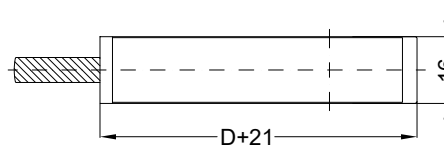
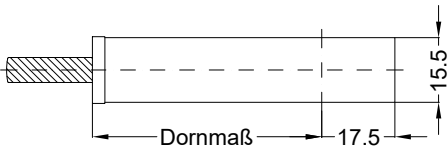

Situation
Riegel

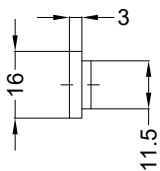

Lage
Schloss

