

Perspektive  
Schloss:

T-F26184 .../DS 92/... M4

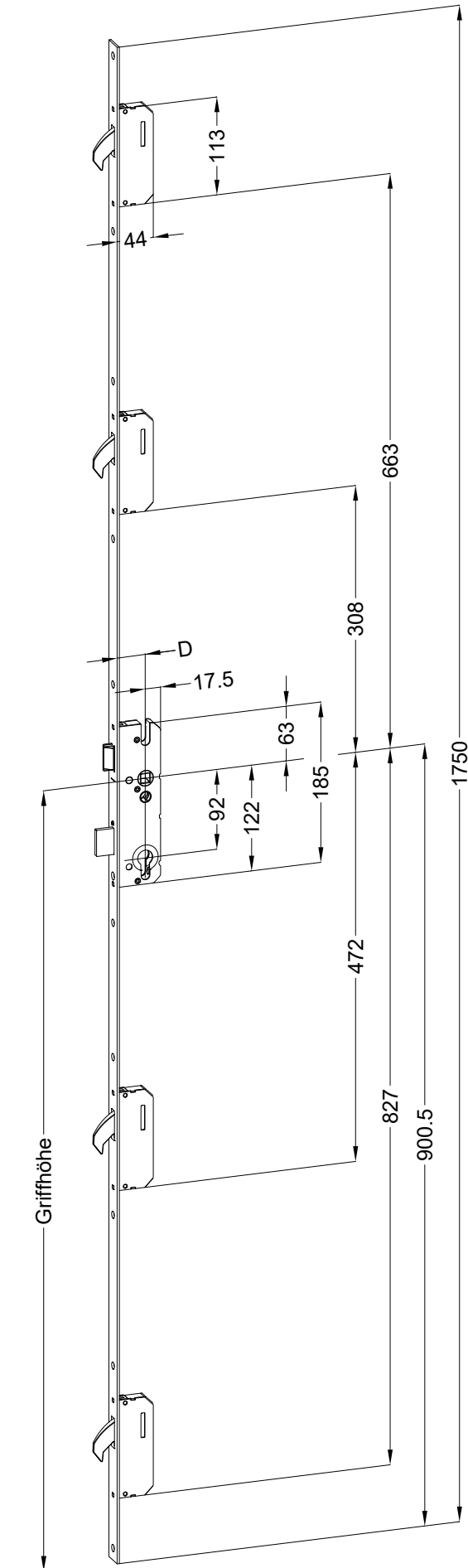

Technische Änderungen vorbehalten!

Schraublage  
Schloss:

T-F26184 .../DS 92/... M4

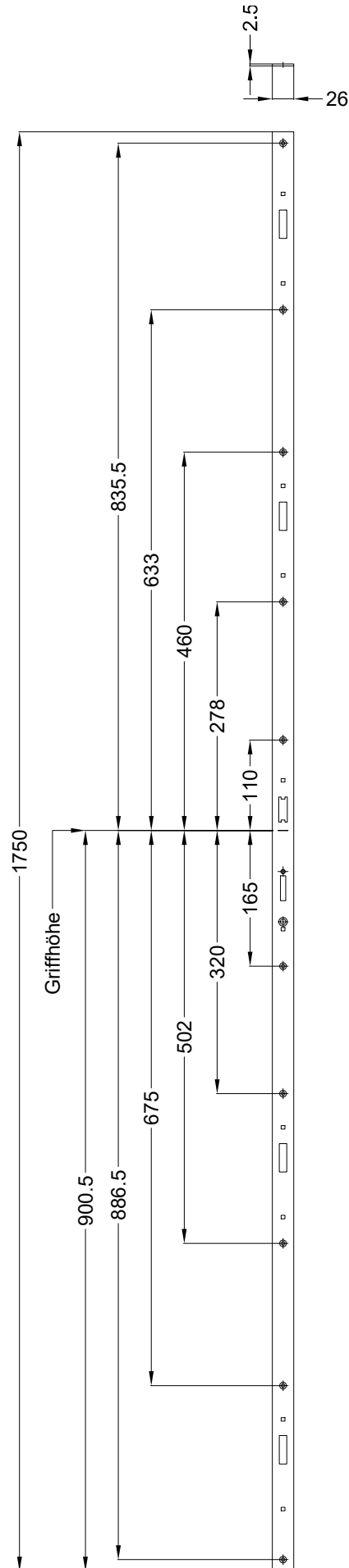

Technische Änderungen vorbehalten!

**Ansichten**  
**Schloss:**

**T-F26184 .../DS 92/... M4**

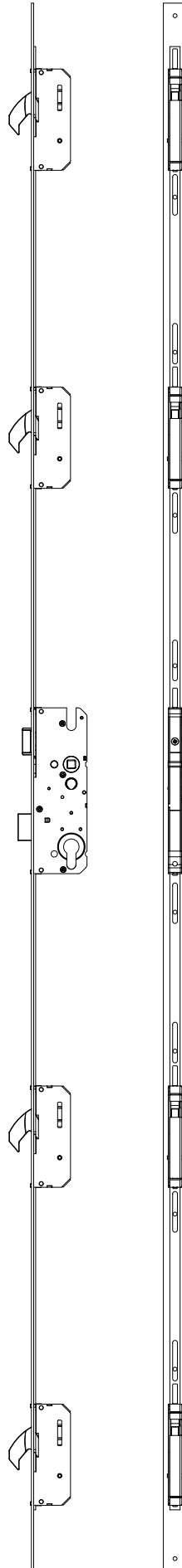

Technische Änderungen vorbehalten!



Allgemeine Vermaung

Frsmae

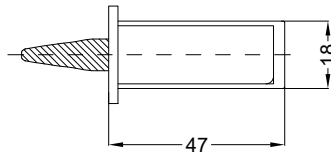
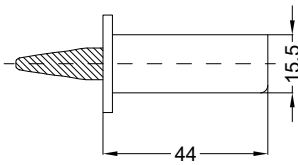

Situation  
 Schwenkriegel  
 G1 Gehuse TM6 Y2K

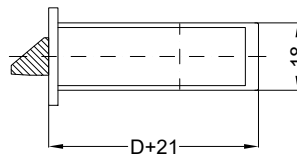
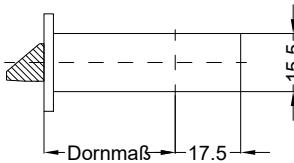

Situation  
 Falle  
 SK TP3

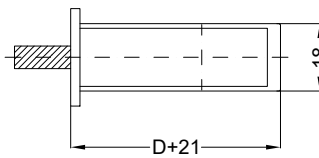
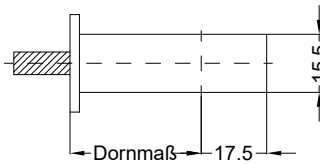

Situation  
 Riegel  
 SK TP3

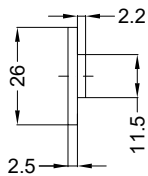

Lage  
 Schloss

