

Perspektive
Schloss:

STV-F 1677/D... 92/... M2

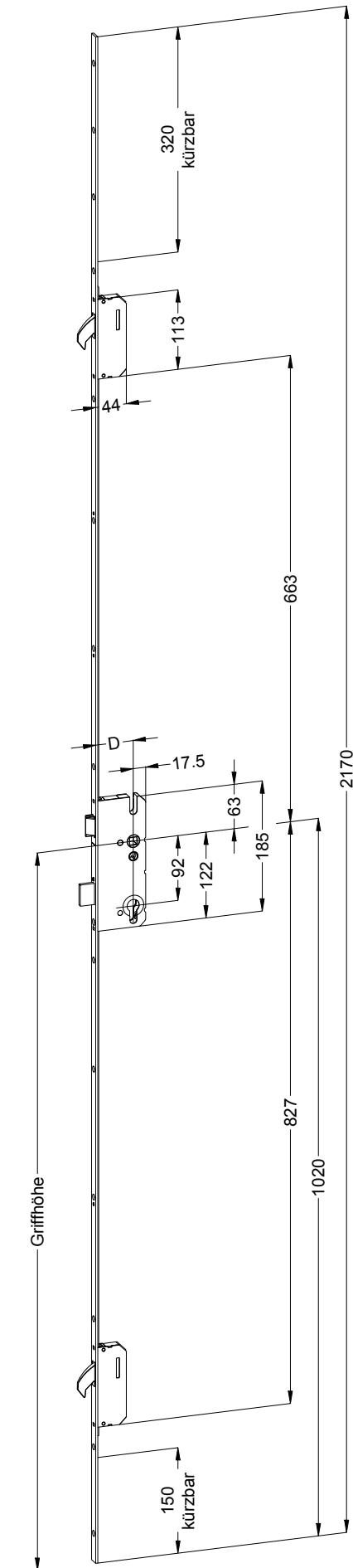

Technische Änderungen vorbehalten!

Schraublage
Schloss:

STV-F 1677/D... 92/... M2



Technische Änderungen vorbehalten!

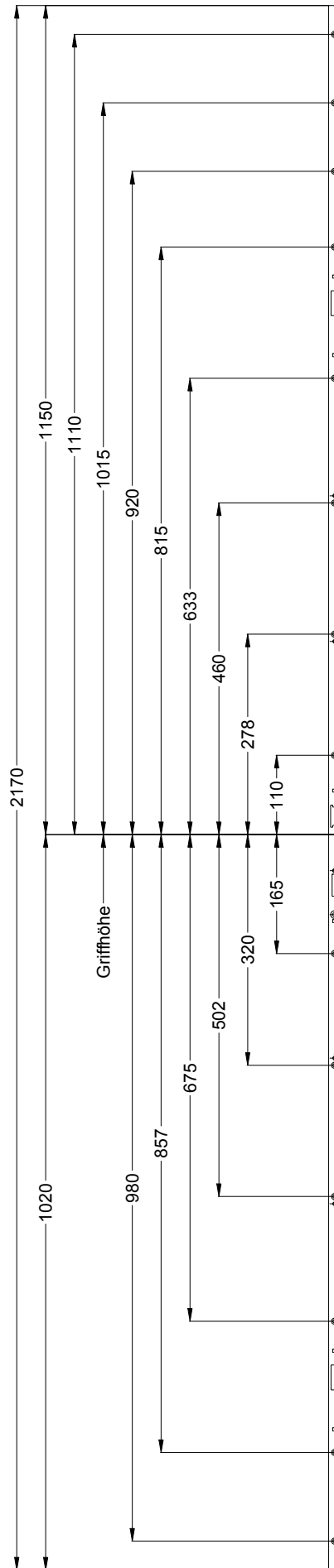

Ansichten
Schloss:

STV-F 1677/D... 92/... M2

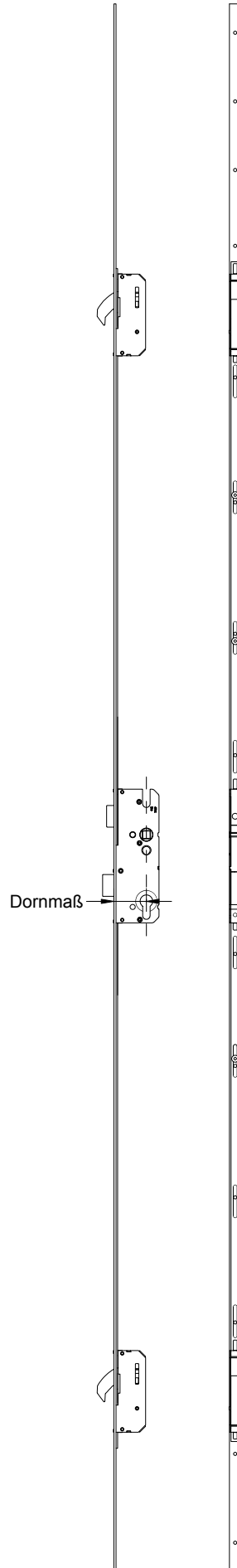

Technische Änderungen vorbehalten!

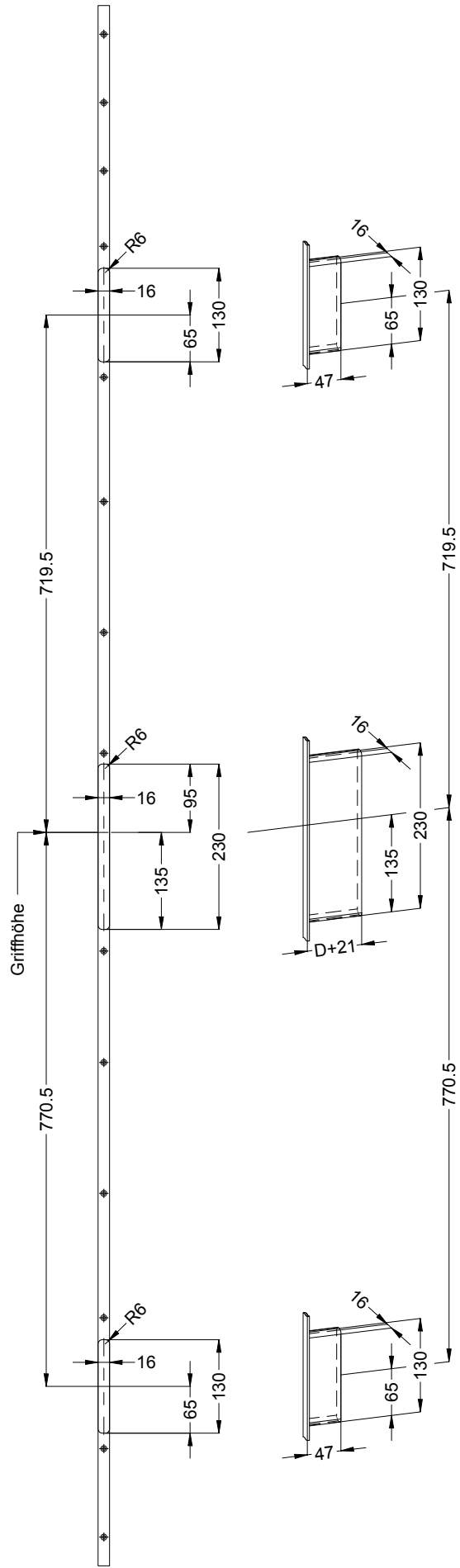

Allgemeine Vermaung

Frsmae

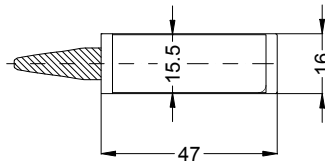
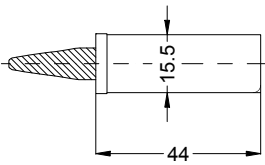

Situation
Schwenkriegel

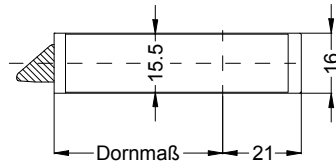
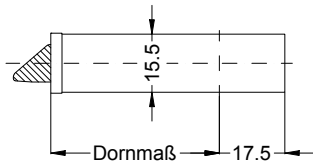

Situation
Falle

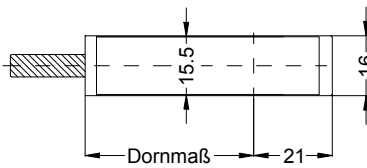
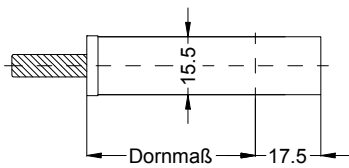

Situation
Riegel

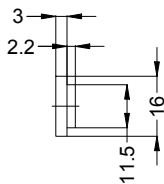

Lage
Schloss

Technische Änderungen vorbehalten!

