

Perspektive
Schloss:

T-AP4 E/B/D1 U24184 .../DS 92/... M2

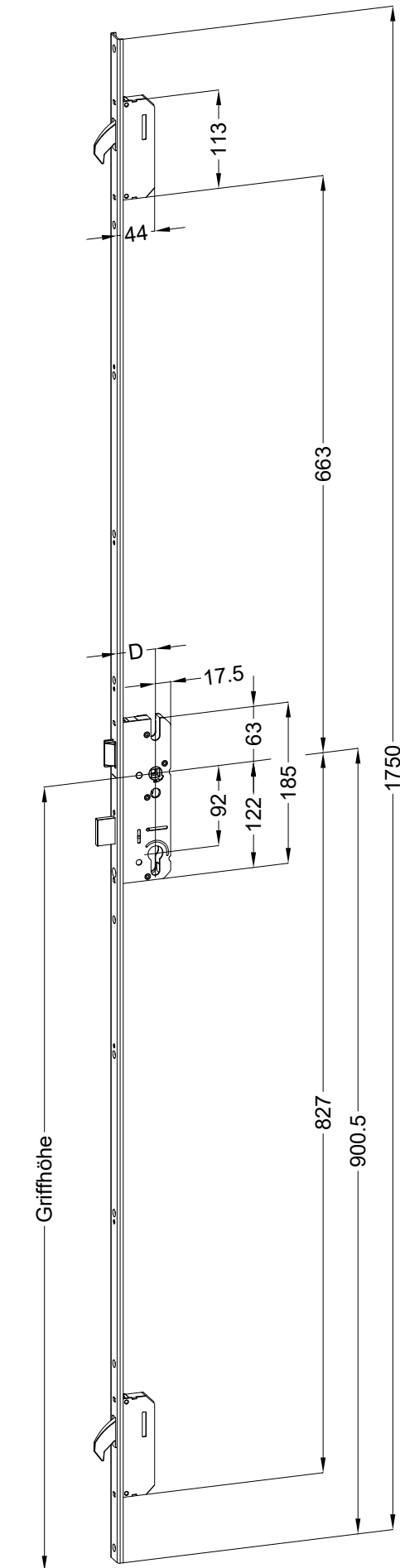

Technische Änderungen vorbehalten!

Schraublage
Schloss:

T-AP4 E/B/D1 U24184 .../DS 92/... M2

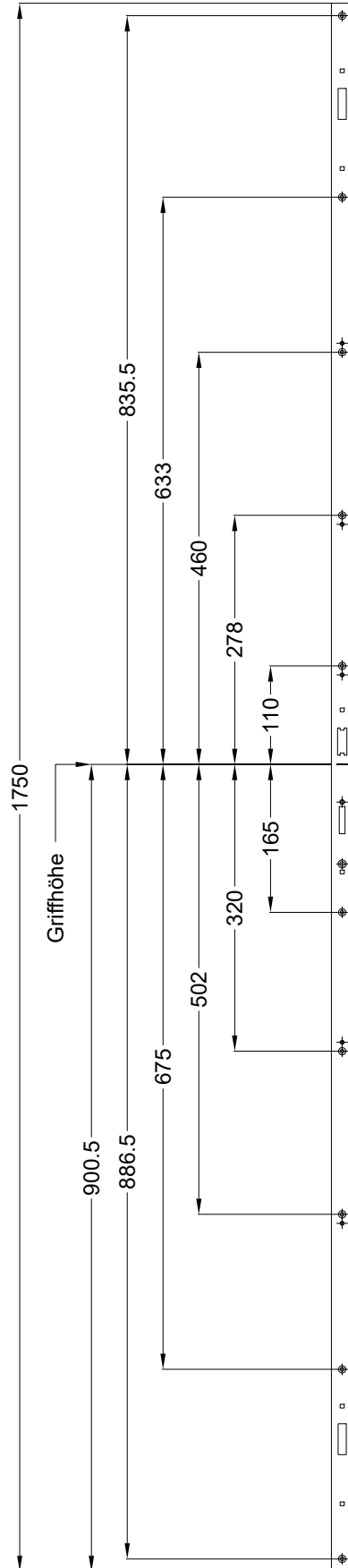
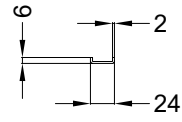

Technische Änderungen vorbehalten!

Ansichten
Schloss:

T-AP4 E/B/D1 U24184 .../DS 92/... M2

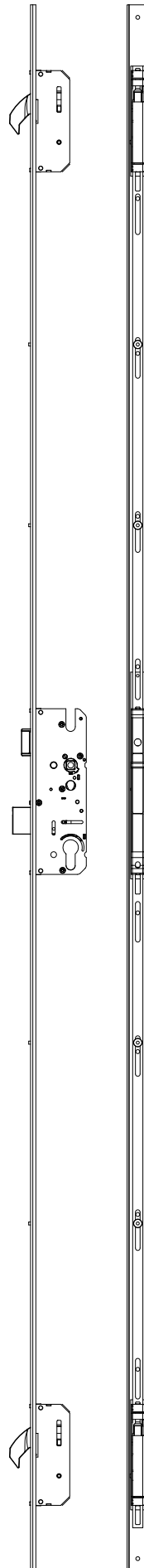

Allgemeine Vermaßung

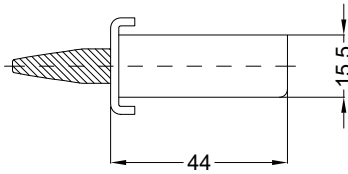

Fräsmaße

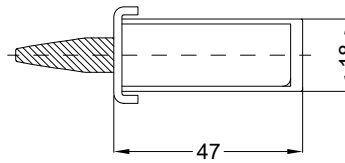

Situation
 Schwenkriegel AP4

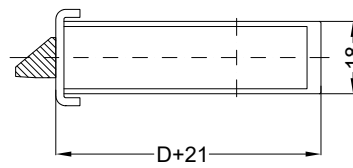
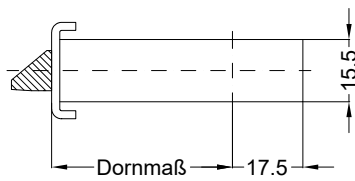

Situation
 Falle
 SK AP4

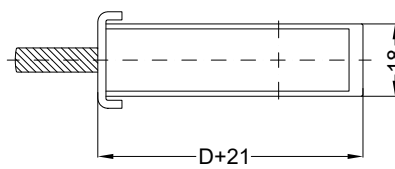
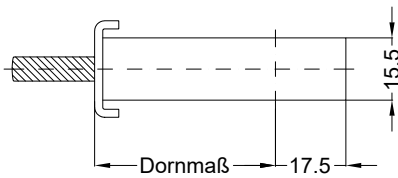

Situation
 Riegel
 SK AP4

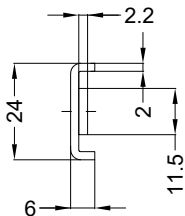

Lage
 Schloss

Empfohlene Fräsung

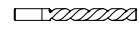

Ø 12

