

Art. 500.8810

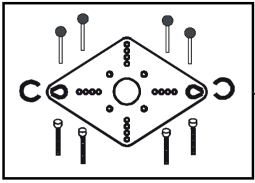

500.8801

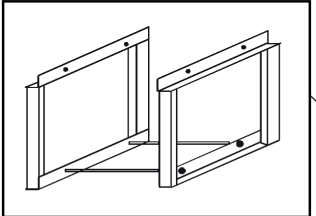

500.8802

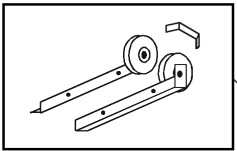

500.8803

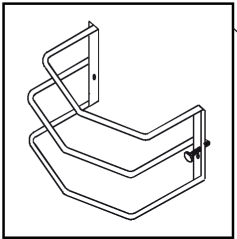

500.8800-R006P

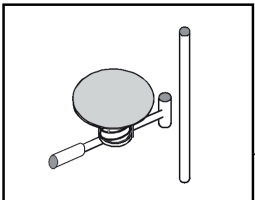

500.8800-R021P

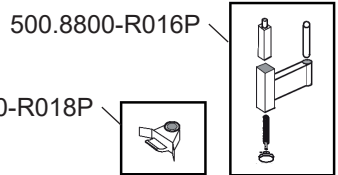

500.8800-R016P



500.8800-R018P



500.8800-R017P

MAX 1500 KG

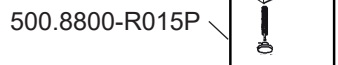

500.8800-R015P

500.8800-R019P

500.8800-R022P

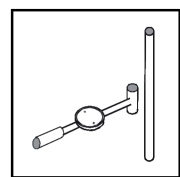

500.8800-R020P

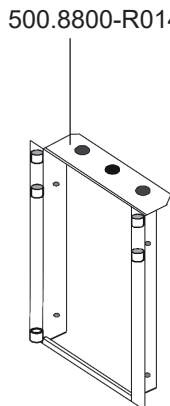

500.8800-R014P

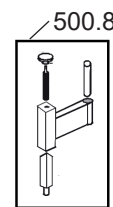

500.8800-R010P

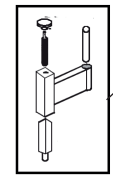

500.8800-R011P

500.8800-R012P

500.8800-R001P

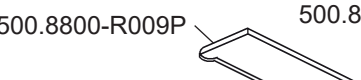

500.8800-R009P

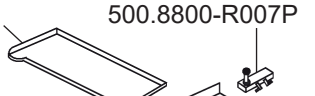

500.8800-R007P

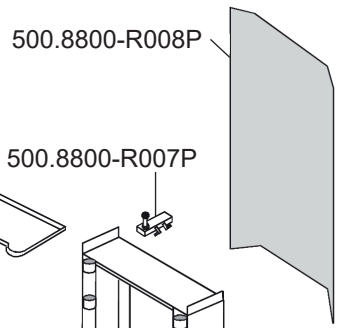

500.8800-R008P

500.8800-R005P



500.8800-R004P

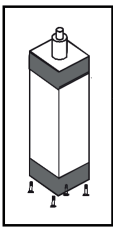

500.8804

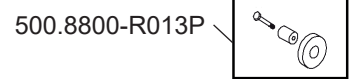

500.8800-R013P

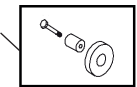

500.8800-R003P

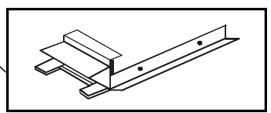

500.8800-R002P

**Art. 500.8810**

Art.-Nr.	Description	Beschreibung	Menge Qty.
500.8801	Adapter for 500.8800	Universal adapter für 500.8800	1
500.8802	Safety stand for pressurised air spring	Gestell für 500.8800	1
500.8803	Replacement wheels set, 2pcs.	Ersatzreifen Set, 2-tlg.	1
500.8804	Conversion Kit for 500.8800	Pneumatik-Einheit für 500.8800	2
500.8800-R001P	Main frame	Hauptrahmen	1
500.8800-R002P	Base	Standfuß	1
500.8800-R003P	Foot pedal set	Fußschalterset	1
500.8800-R004P	Air hose kit	Druckluftzuführung	1
500.8800-R005P	Safety valve switch	Sicherheitsventilschalter	1
500.8800-R006P	Safety bar	Sicherheitsbügel	1
500.8800-R007P	Main switch joystick	Hauptschalter- Joystick	1
500.8800-R008P	Back panel	Rückwand	1
500.8800-R009P	Tool tray	Ablageschale	1
500.8800-R010P	Adjustable clamping arm, top left	Einstellbarer Spannarm, links oben	1

Art.-Nr.	Description	Beschreibung	Menge Qty.
500.8800-R011P	Adjustable clamping arm, top right	Einstellbarer Spannarm, rechts oben	1
500.8800-R012P	Safety steel cable	Sicherheits-Stahlkabel	1
500.8800-R013P	Bearing	Kugellager	1
500.8800-R014P	Guided sliding frame	Führungsschlitten	1
500.8800-R015P	Adjustable clamping arm, bottom right	Einstellbarer Spannarm, rechts unten	1
500.8800-R016P	Adjustable clamping arm, bottom left	Einstellbarer Spannarm, links unten	1
500.8800-R017P	Small clamp	Kralle klein	1
500.8800-R018P	Large clamp	Kralle groß	1
500.8800-R019P	Pad für suspension strut support	Platte für Federbeinhalter	1
500.8800-R020P	Steel tubes for suspension strut	Gestänge für Federbeinhalter	1
500.8800-R021P	Suspension strut support	Federbeinhalter	1
500.8800-R022P	Spring for plate of strut holder	Feder für Federbeinhalter-platte	1