

Perspektive
Schloss:

T-AV3-F2067 .../D A9 92/... M2 RS
DIN LS spiegelbildlich

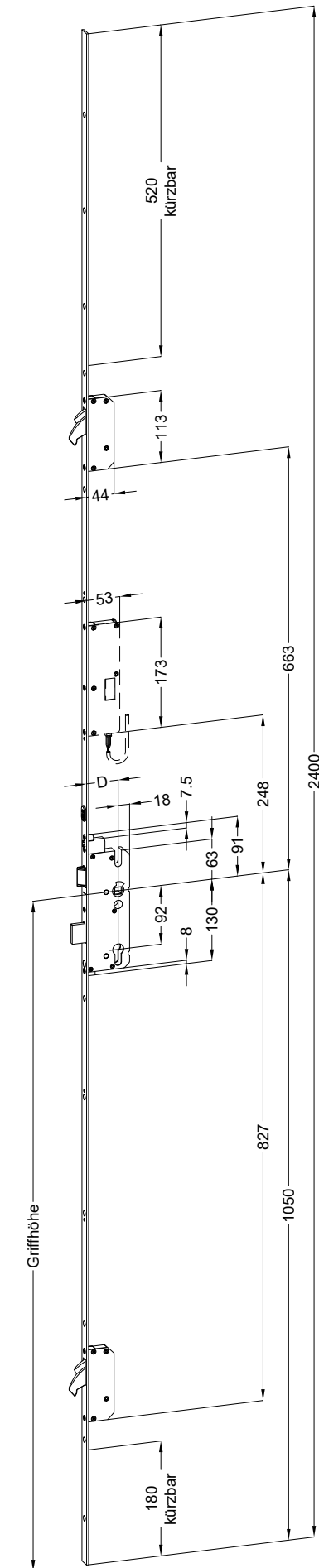

Technische Änderungen vorbehalten!

Schraublage
Schloss:

T-AV3-F2067 .../D A9 92/... M2 RS
DIN LS spiegelbildlich

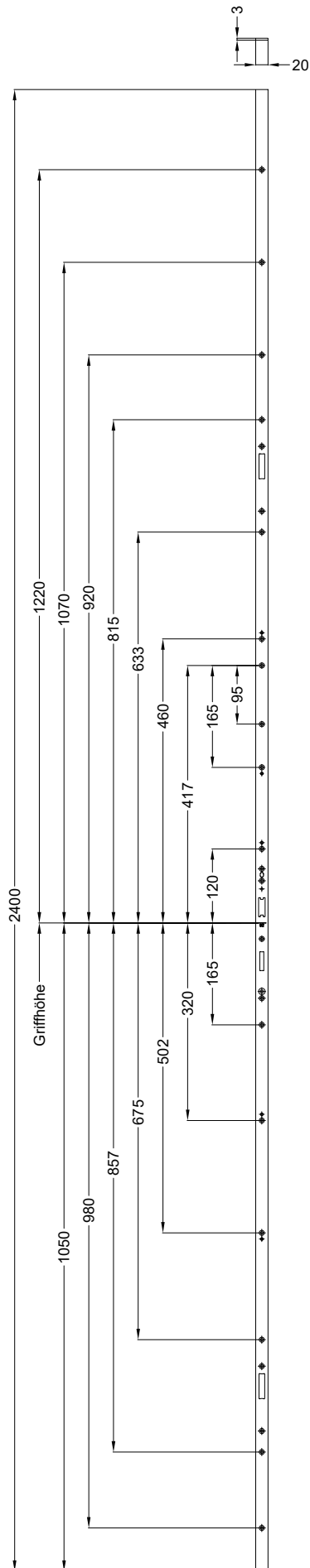

Technische Änderungen vorbehalten!

Ansichten
Schloss:

T-AV3-F2067 .../D A9 92/... M2 RS
DIN LS spiegelbildlich

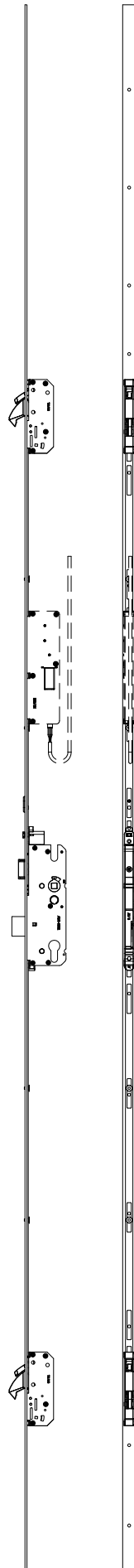

Technische Änderungen vorbehalten!

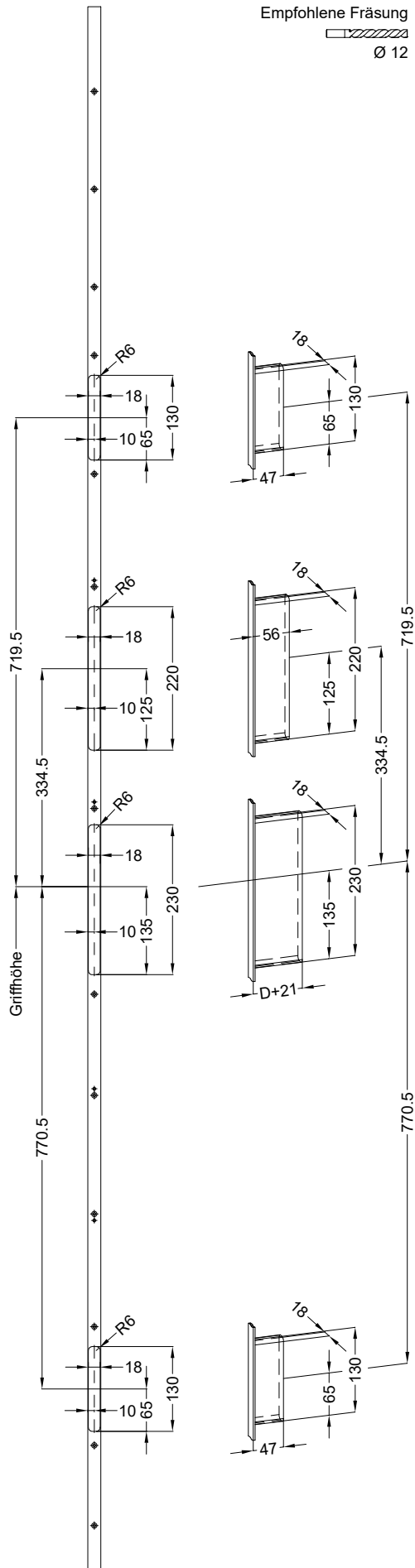

Einbausituationen der Bauteile mit Fräsmaßen

Schloss: T-AV3-F2067 .../D A9 92/... M2 RS
DIN LS spiegelbildlich



Allgemeine Vermaung

Frsmae

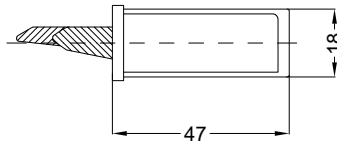
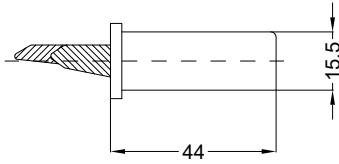

Situation
Schwenkriegel
TM AV3 SK RS

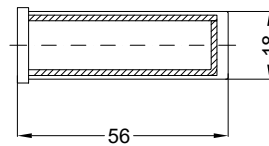
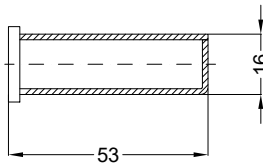

Situation
Motorkasten EAV

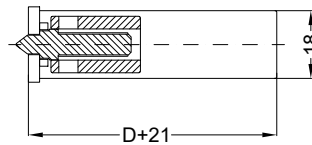
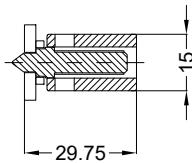

Situation
Taststift
SK AV3

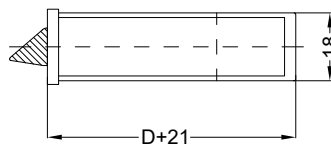
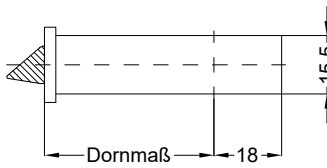

Situation
Falle
SK AV3

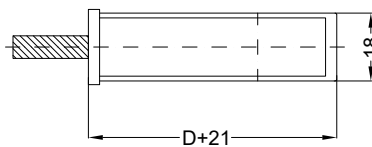
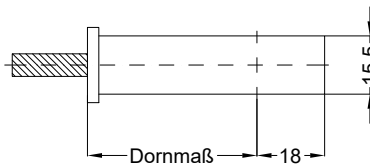

Situation
Riegel
SK AV3

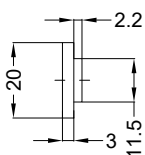

Lage
Schloss

Katalogdarstellung

Schloss: T-AV3-F2067 .../D A9 92/... M2 RS
DIN LS spiegelbildlich



Empfohlene Fräsung
Ø 12

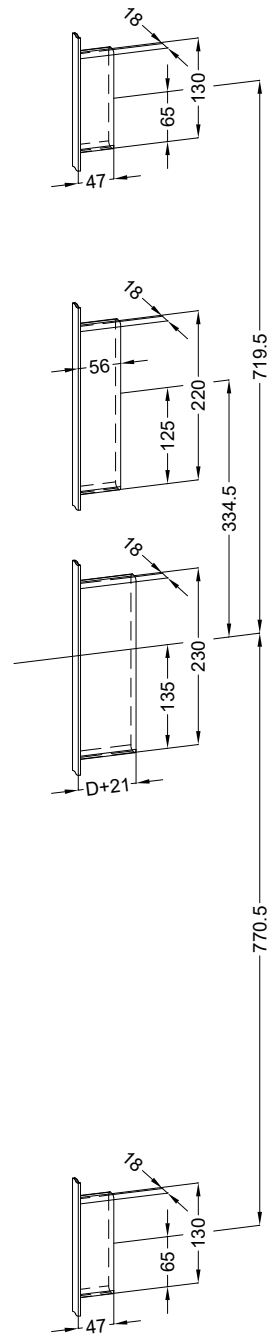
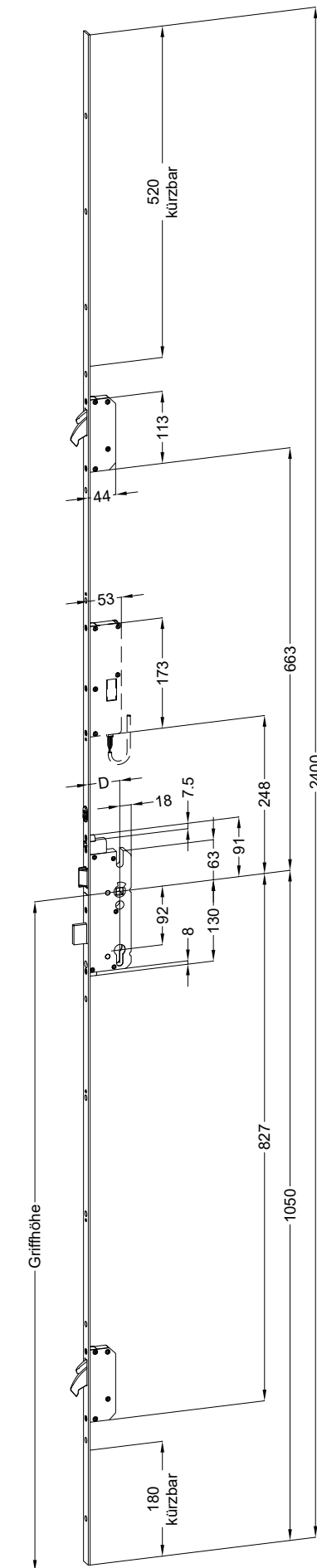

Technische Änderungen vorbehalten!