

Ansichten
Schloss:

T-UW2293 .../D S 92/... M2

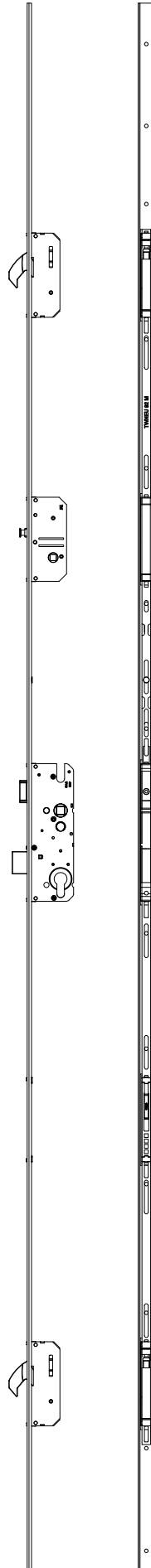

Technische Änderungen vorbehalten!

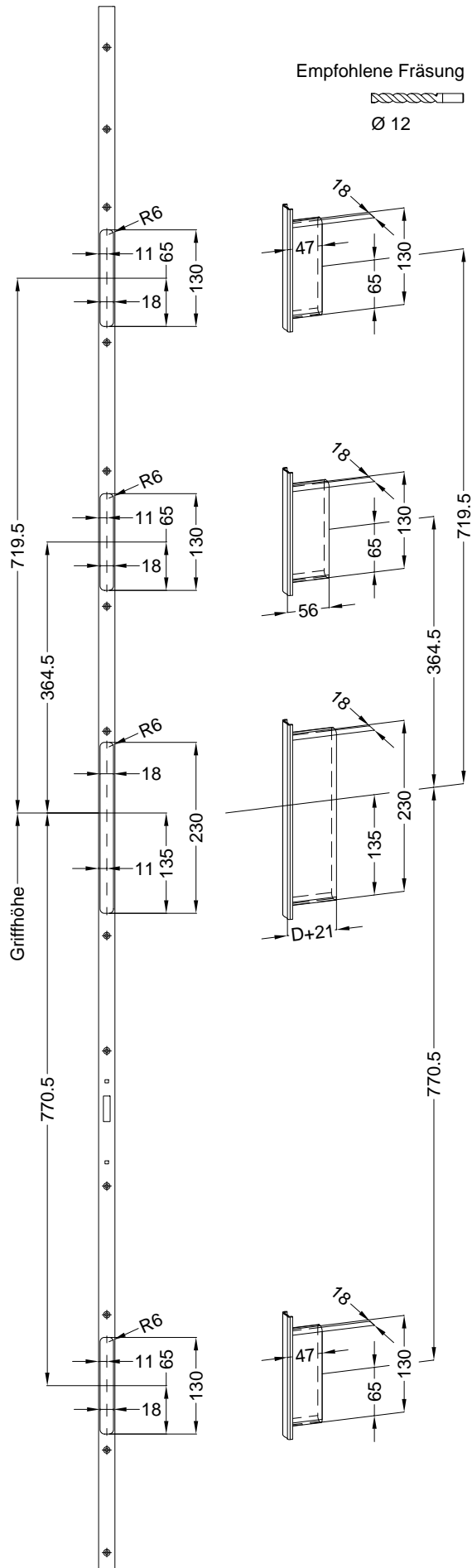

Allgemeine Vermaung

Frsmae

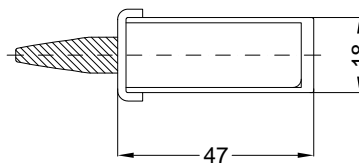
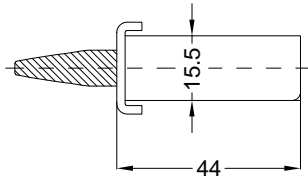

Situation
Schwenkriegel

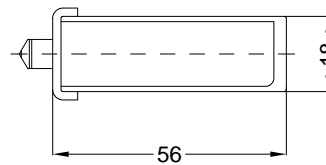
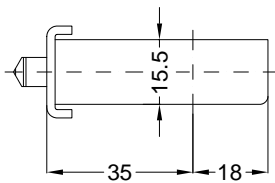

Situation
Trwchter

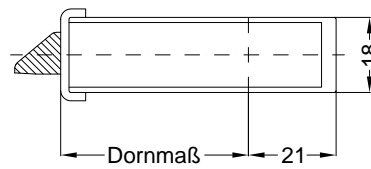
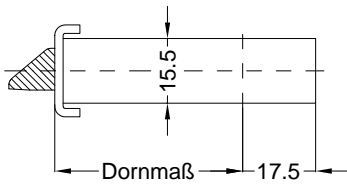

Situation
Falle

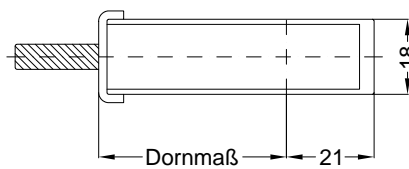
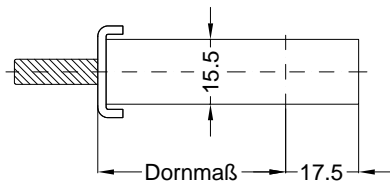

Situation
Riegel

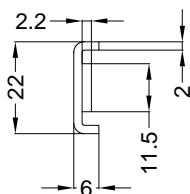

Lage
Schloss

