

Schraublage  
Schloss:

T-BM-EN179/1125-F2060 .../DS 92/... M2

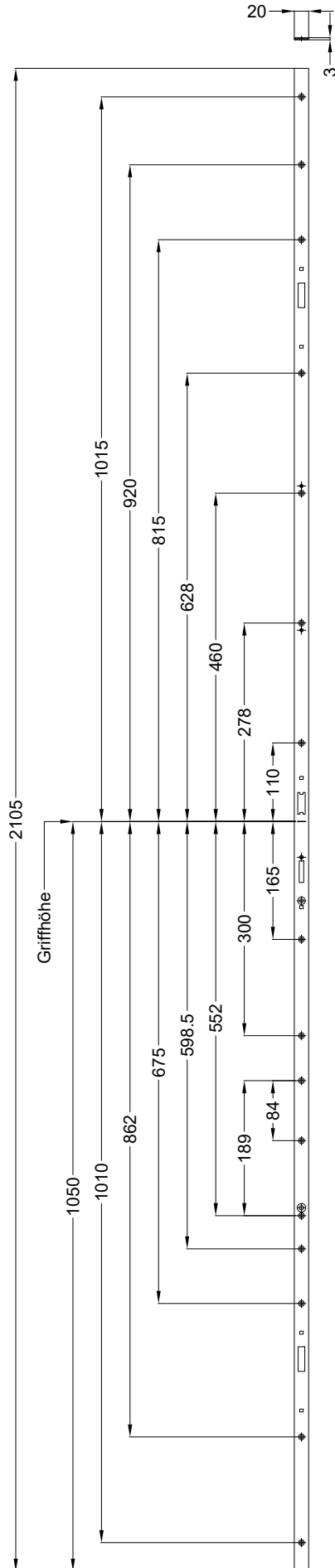

Technische Änderungen vorbehalten!

Ansichten  
Schloss:

T-BM-EN179/1125-F2060 .../DS 92/... M2

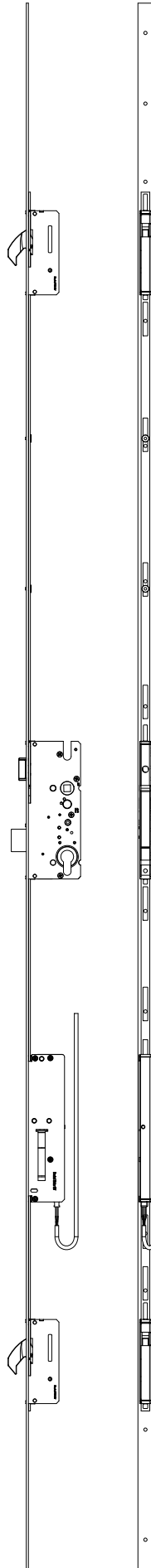

Technische Änderungen vorbehalten!

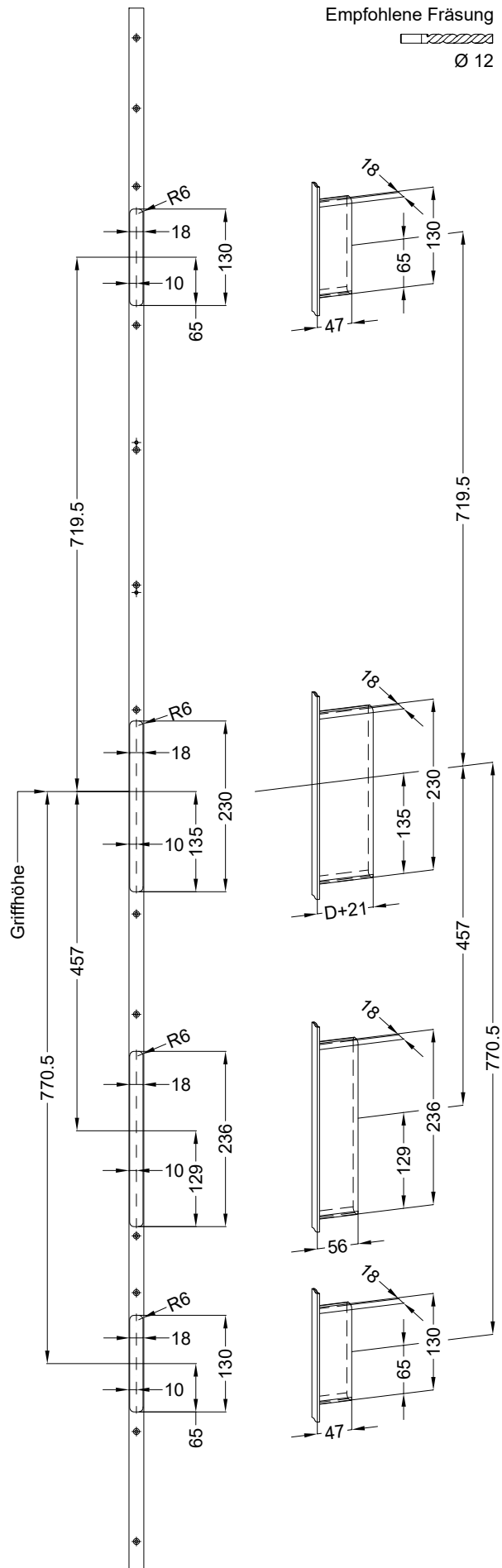

Einbausituationen der Bauteile mit Fräsmaßen

Schloss: T-BM-EN179/1125-F2060 .../DS 92/... M2



Allgemeine Vermaung

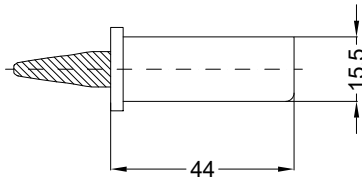

Frsmae

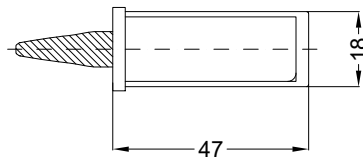

Situation  
Schwenkriegel

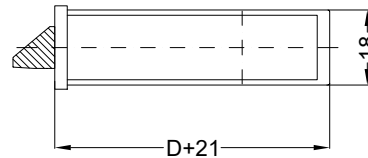
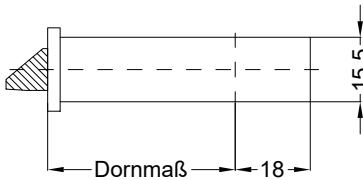

Situation  
Falle

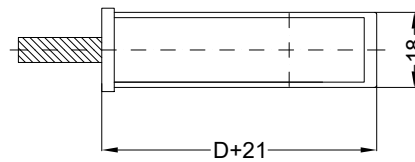
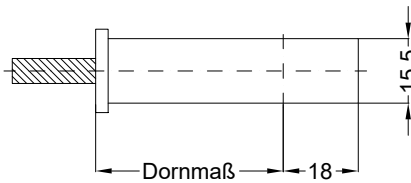

Situation  
Riegel

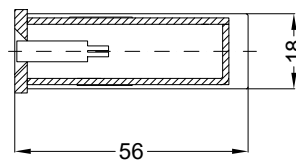
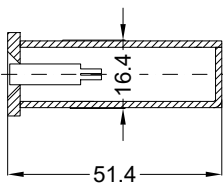

Situation  
Motorkasten

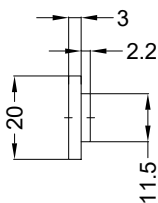

Lage  
Schloss

Technische Änderungen vorbehalten!

