

Perspektive  
Schloss:

T-FGA01670 .../D 92/... D2  
(Zusatzschloss optional)

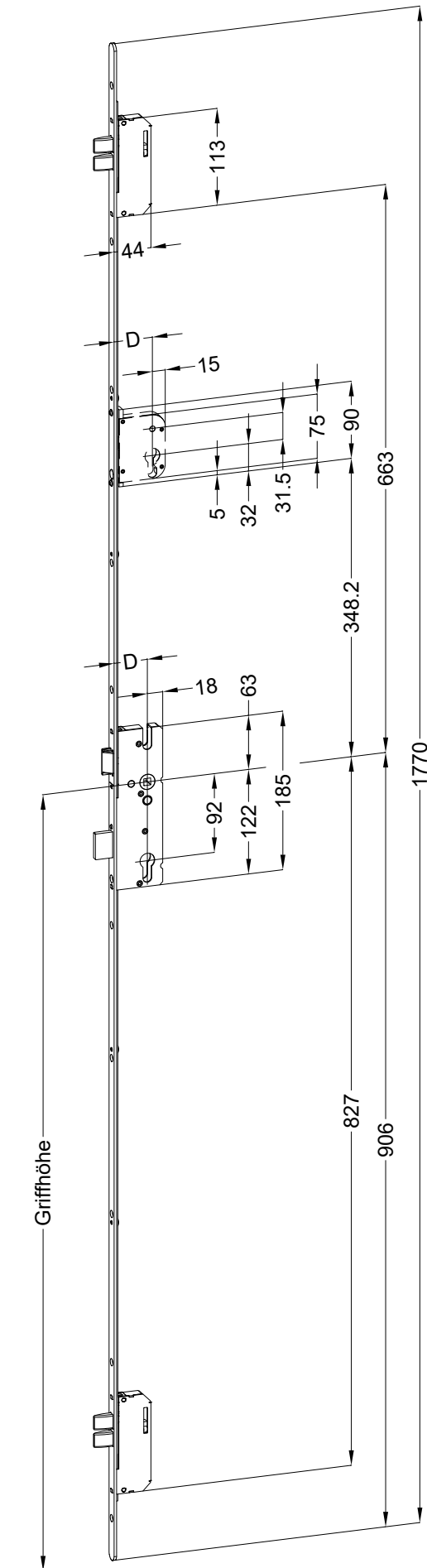

Technische Änderungen vorbehalten!

Schraublage

Schloss:

T-FGAO1670 .../D 92/... D2  
(Zusatzschloss optional)

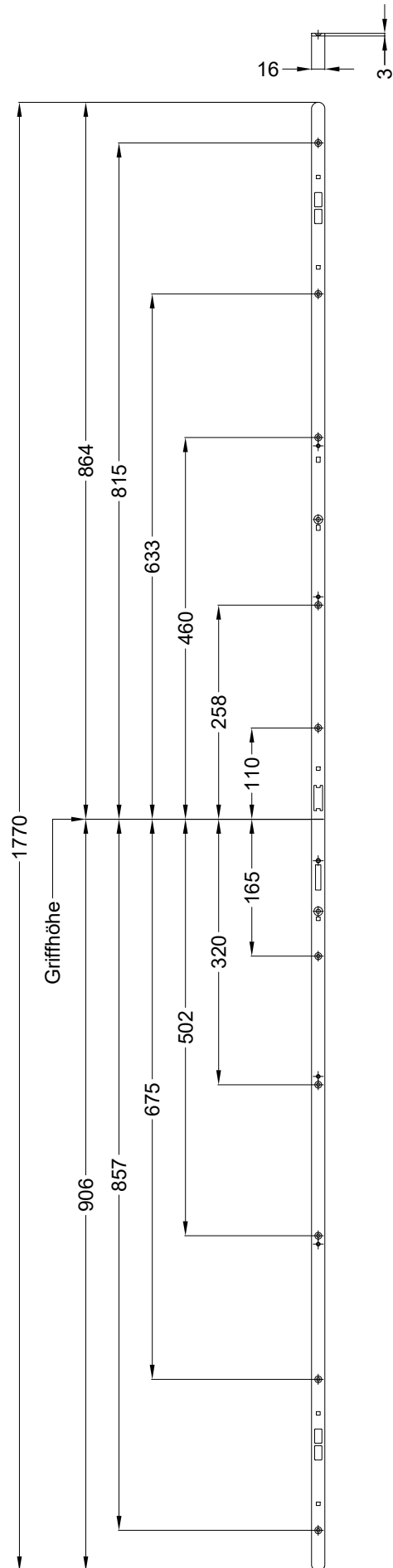

Technische Änderungen vorbehalten!

**Ansichten**  
**Schloss:**

**T-FGA01670 .../D 92/... D2**  
**(Zusatzschloss optional)**



Technische Änderungen vorbehalten!

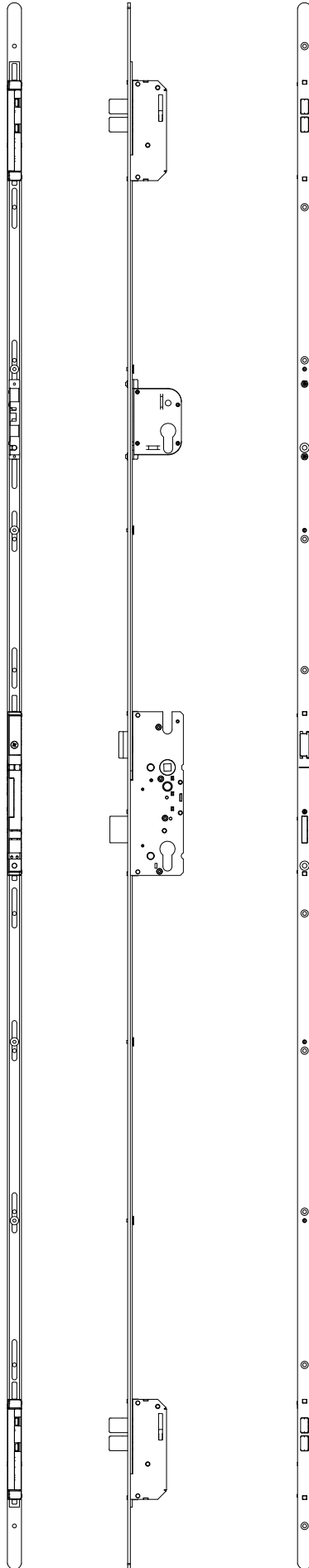

Fräsmaße

Schloss: T-FGA01670 .../D 92/... D2  
(Zusatzschloss optional)



Empfohlene Fräsung

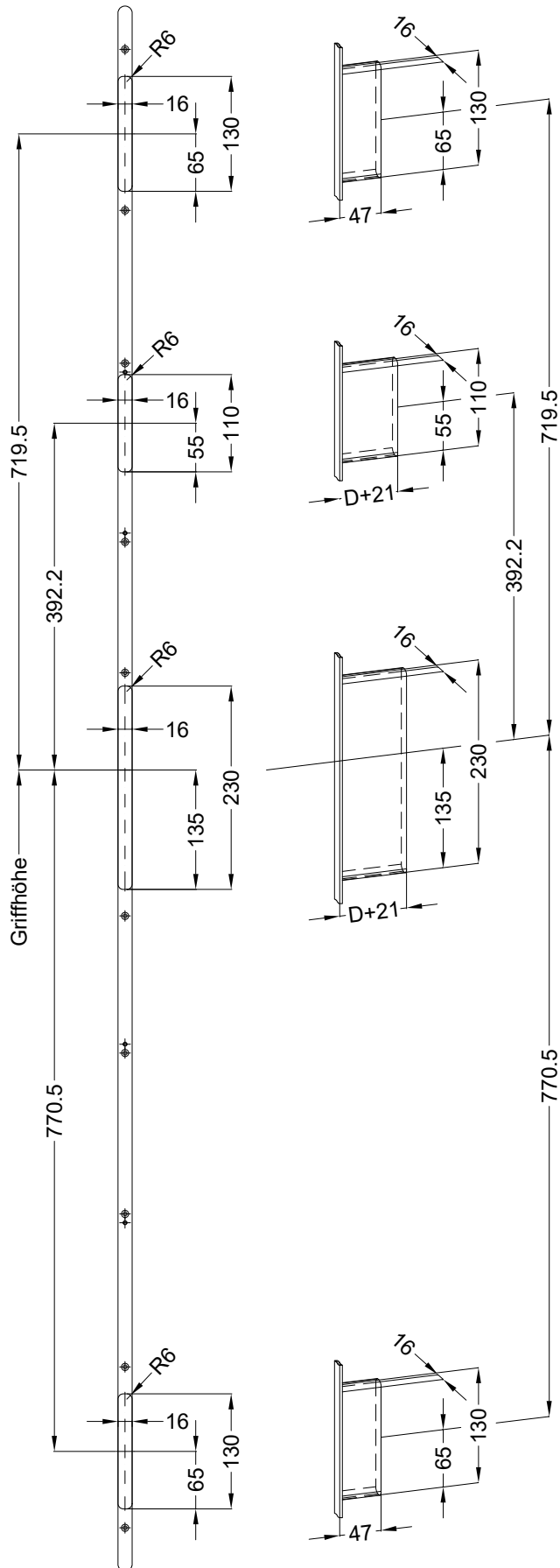
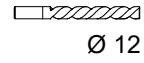

**Einbausituationen der Bauteile mit Fräsmaßen**  
**Schloss: T-FGA01670 .../D 92/... D2**  
**(Zusatzschloss optional)**



**Allgemeine Vermaung**

**Frsmae**

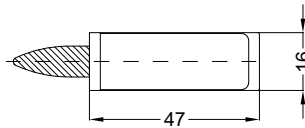
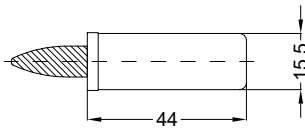

Situation  
 Bolzen TD6

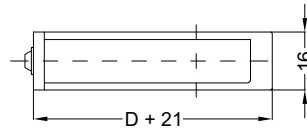
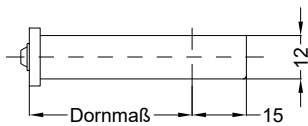

Situation Zusatzschloss  
 T-FA-G2 GEHUSE M3

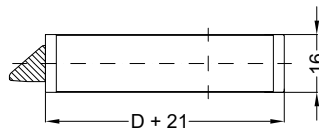
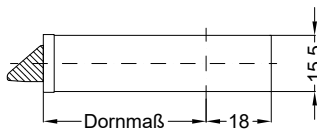

Situation  
 Falle

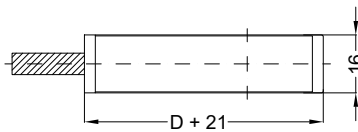
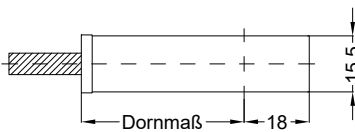

Situation  
 Riegel

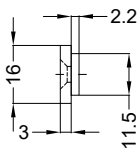

Lage  
 Schloss

Katalogdarstellung

Schloss: T-FGA01670 .../D 92/... D2  
(Zusatzschloss optional)



Empfohlene Fräsung

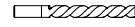

Ø 12

