

Schraublage  
Schloss:

T-FG1660 ... /35 92/ ... M2 R2

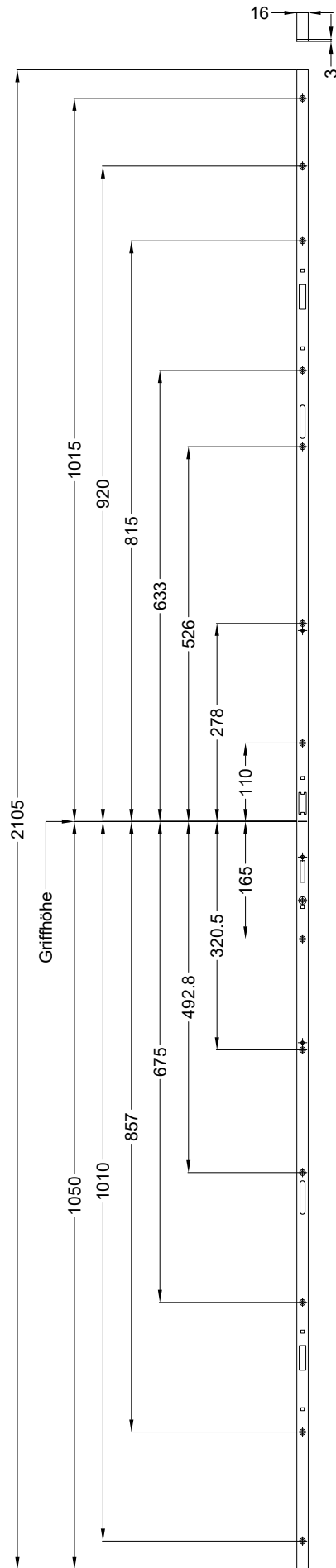

Technische Änderungen vorbehalten!

Ansichten  
Schloss:

T-FG1660 ... /35 92/ ... M2 R2

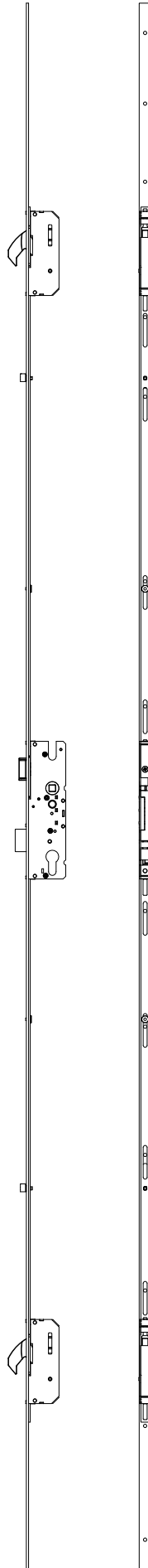

Technische Änderungen vorbehalten!



Allgemeine Vermaßung

Fräsmaße

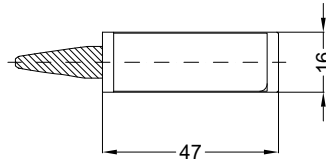
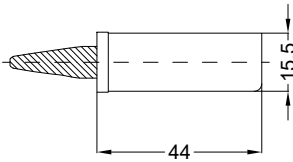

Situation  
 Schwenkriegel  
 Gehäuse TM6 Y2K BL

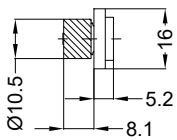

Situation  
 Exzentrerschliessbolzen SL

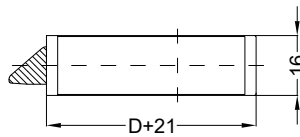
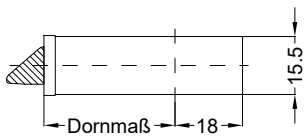

Situation  
 Falle  
 SK TT

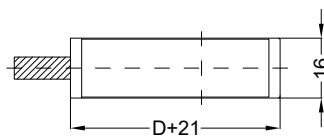
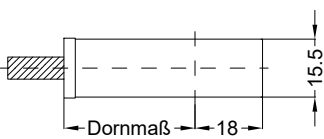

Situation  
 Riegel  
 SK TT

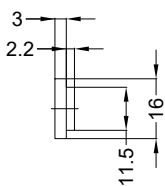

Lage  
 Schloss

# Katalogdarstellung

Schloss: T-FG1660 ... /35 92/ ... M2 R2

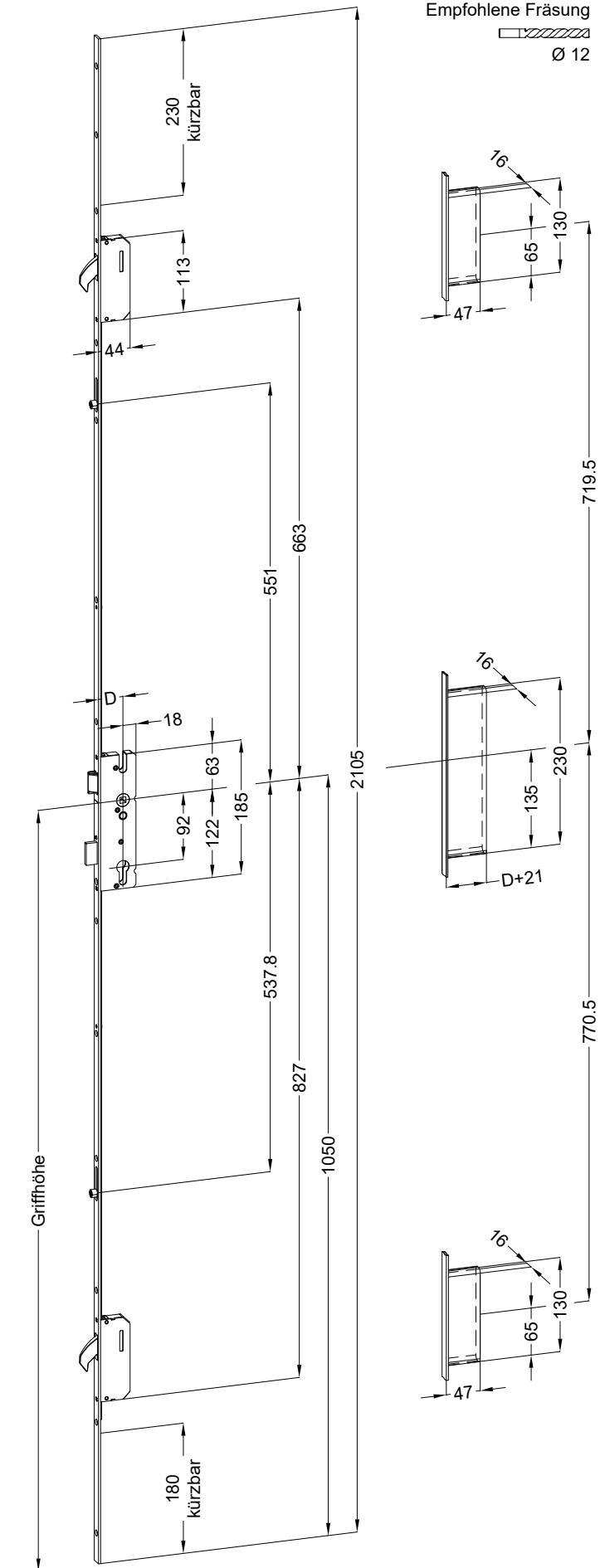

Technische Änderungen vorbehalten!