

**Ansichten**  
**Schloss:**

**T-FG16175 .../D 92/... R4**

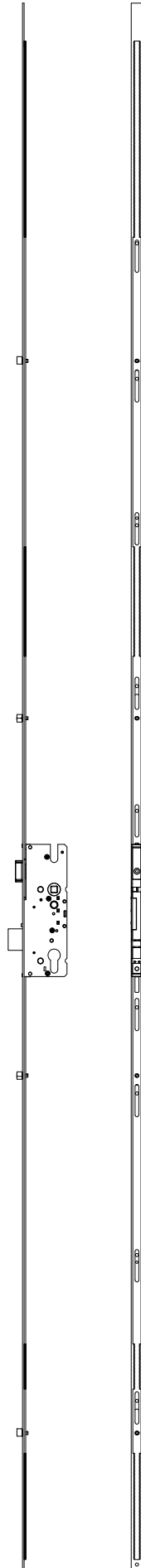

Technische Änderungen vorbehalten!

Fräsmaße  
Schloss:

T-FG16175 .../D 92/... R4

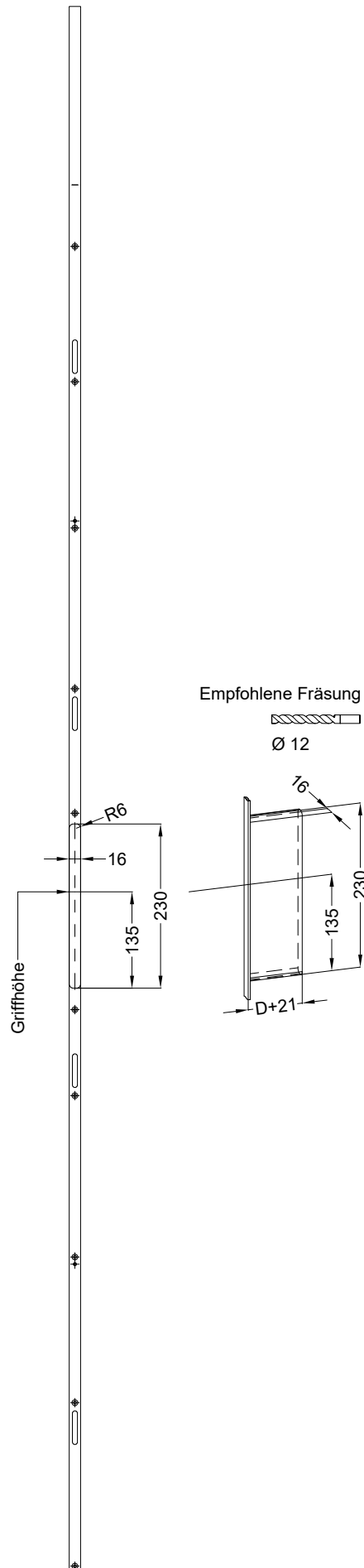

**Allgemeine Vermaung**

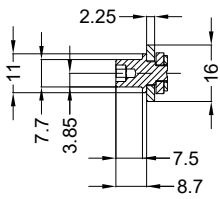

**Frsmae**

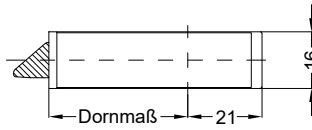
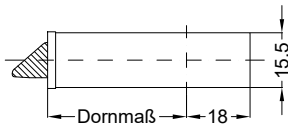

Situation  
 Schliessbolzen  
 Exzenter-schliebolzen SL

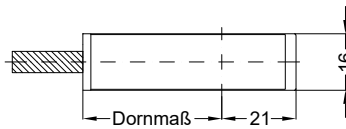
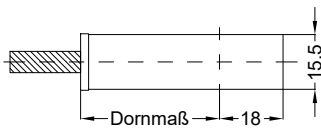

Situation  
 Falle

Situation  
 Riegel

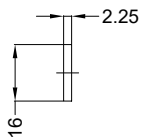

Lage  
 Schloss

Technische Änderungen vorbehalten!

