

Perspektive  
Schloss: T-F2069 .../D 92/... M3 RS

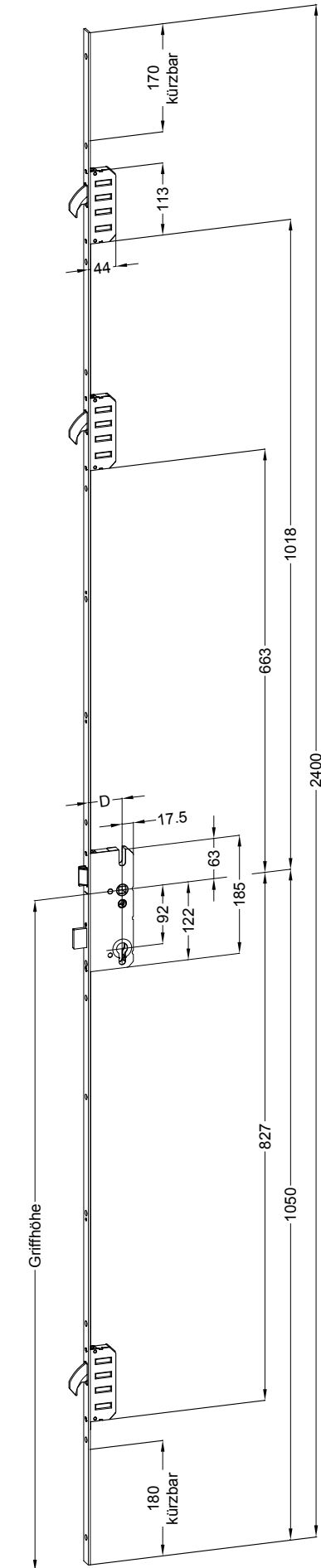

Technische Änderungen vorbehalten!



Schraublage  
Schloss: T-F2069 .../D 92/... M3 RS

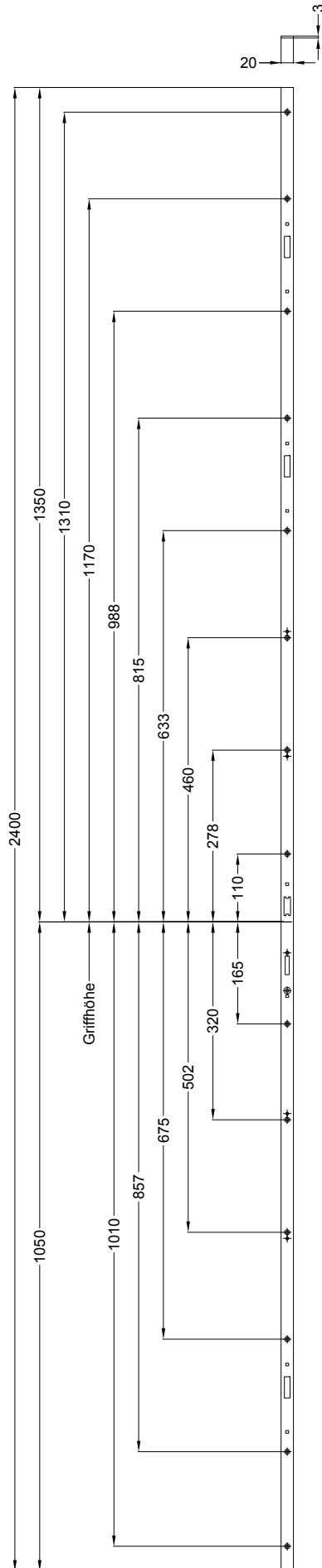

Ansichten

Schloss: T-F2069 .../D 92/... M3 RS

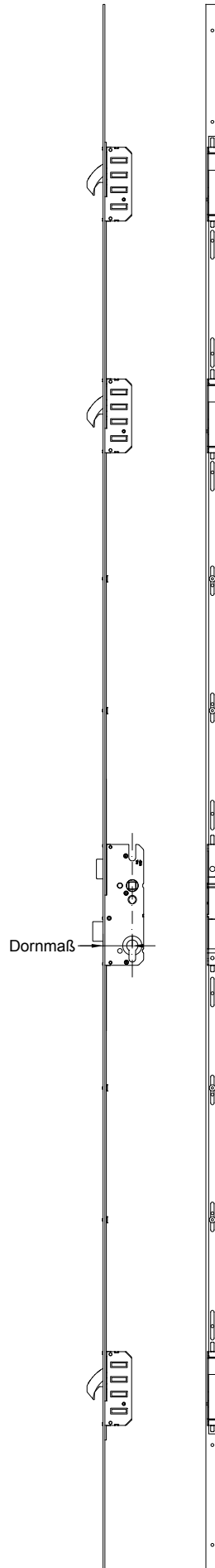

Technische Änderungen vorbehalten!

Fräsmaße

Schloss: T-F2069 .../D 92/... M3 RS

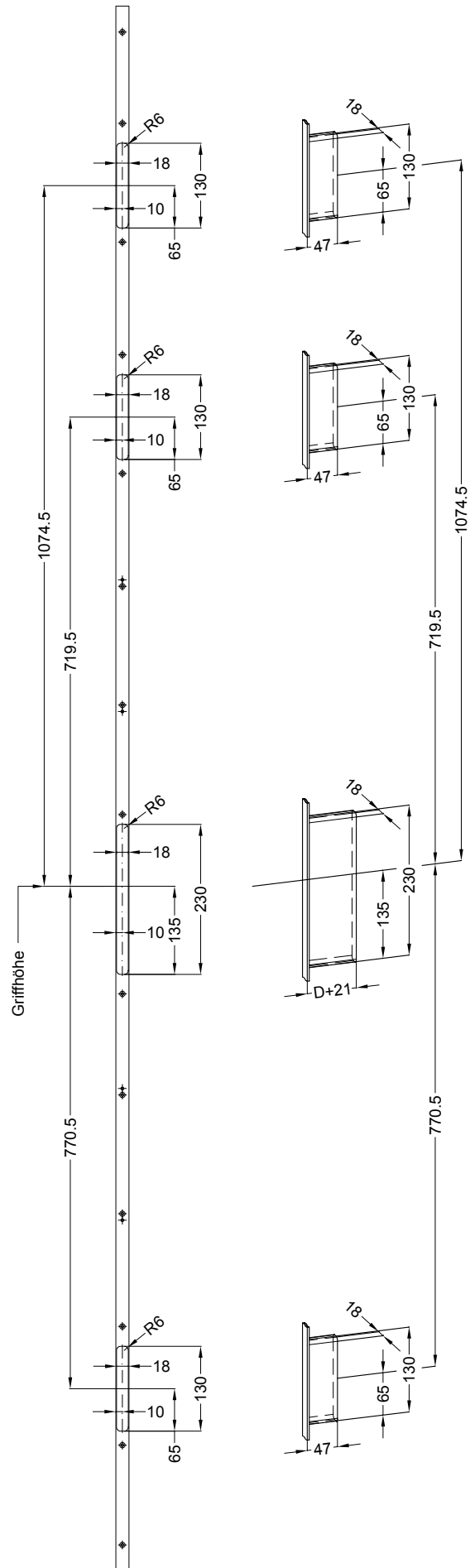

Technische Änderungen vorbehalten!

Allgemeine Vermaung

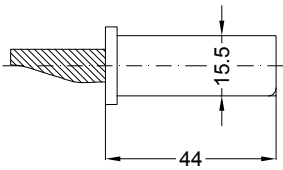

Frsmae

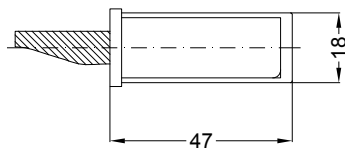

Situation  
 Schwenkriegel

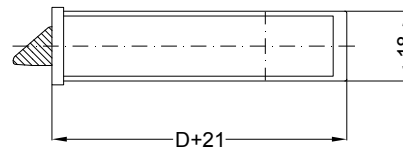
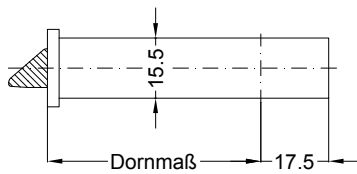

Situation  
 Falle

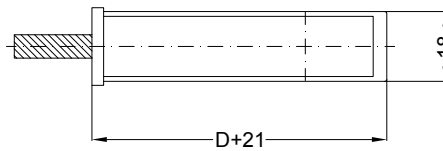
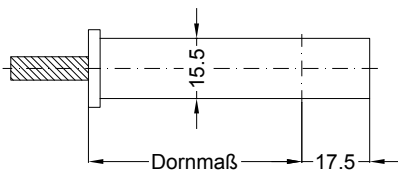

Situation  
 Riegel

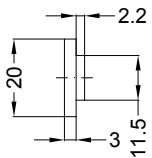

Lage  
 Schloss

Katalogdarstellung  
 Schloss: T-F2069 .../D 92/... M3 RS



Technische Änderungen vorbehalten!

