

Perspektive
Schloss:

T-AP4 E/B/D1 U24184 62 .../DS 92/... M2

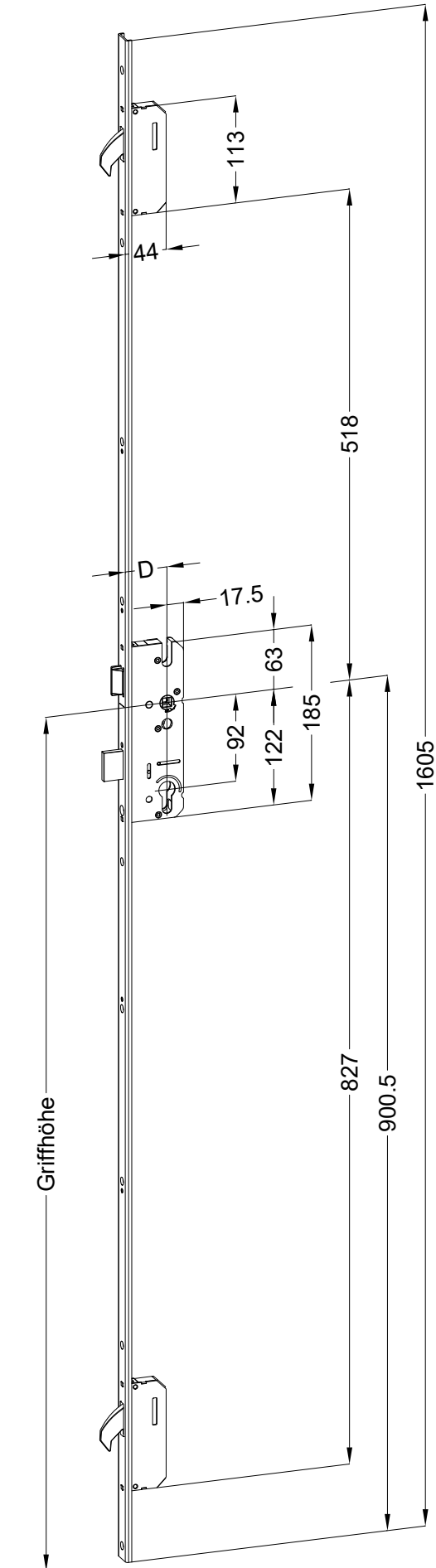

Technische Änderungen vorbehalten!

Schraublage
Schloss:

T-AP4 E/B/D1 U24184 62 .../DS 92/... M2

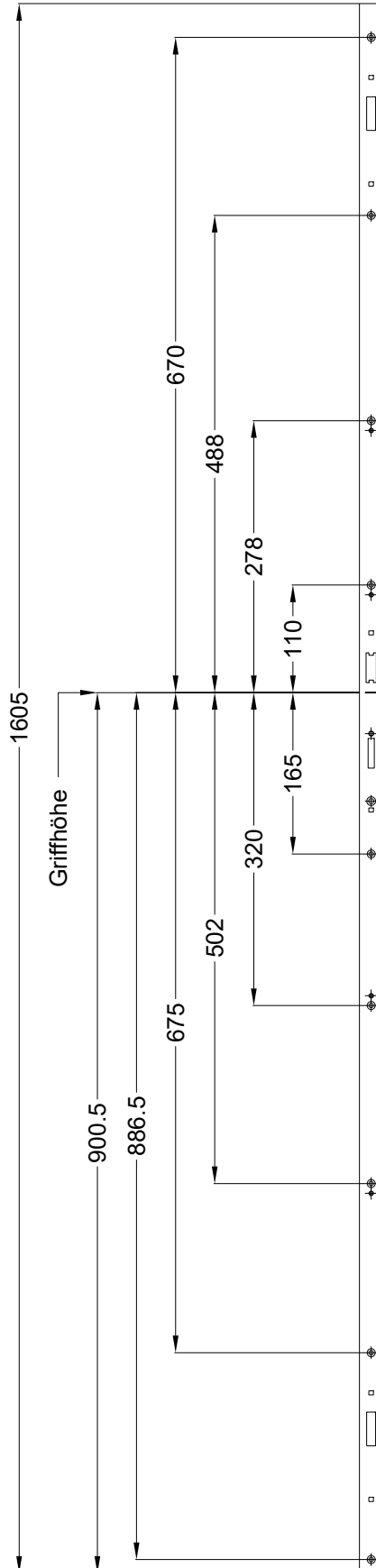
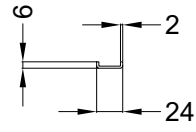

Technische Änderungen vorbehalten!

Ansichten
Schloss:

T-AP4 E/B/D1 U24184 62 .../DS 92/... M2

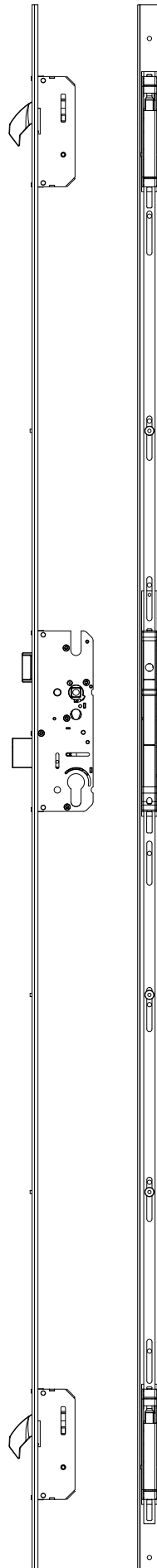

Technische Änderungen vorbehalten!

Empfohlene Fräsung

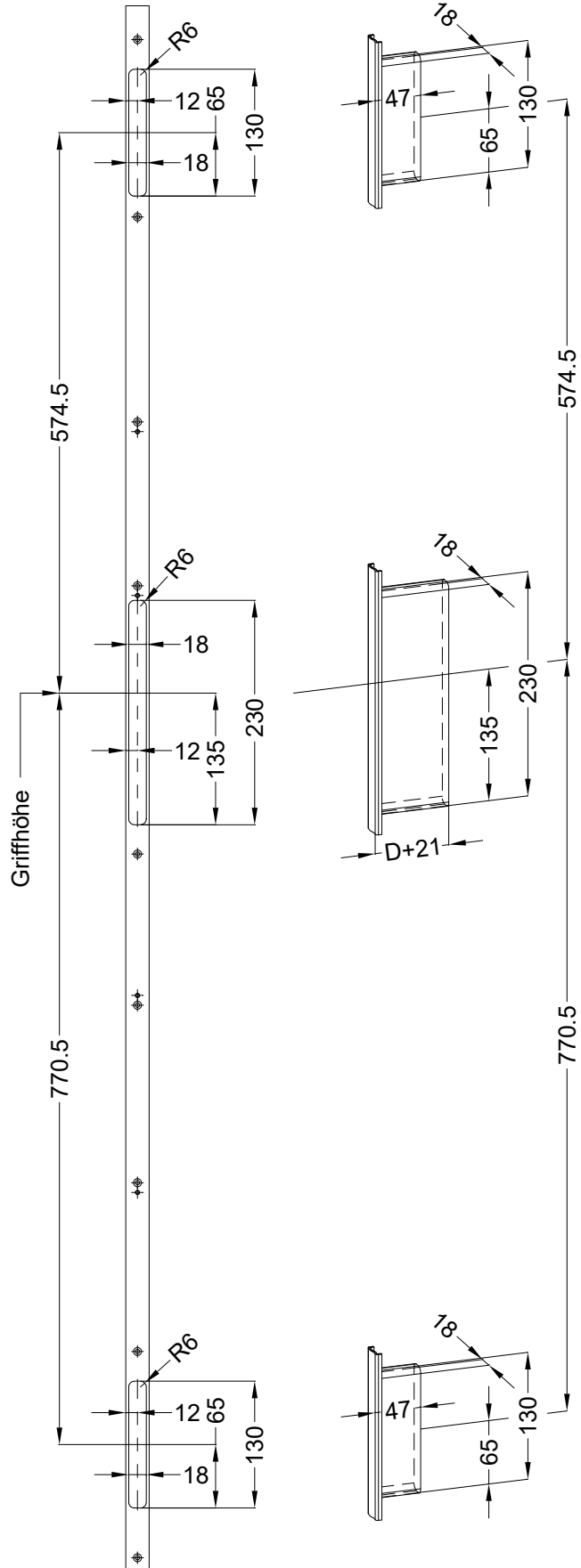
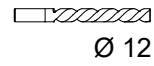

Einbausituationen der Bauteile mit Fräsmaßen

Schloss: T-AP4 E/B/D1 U24184 62 .../DS 92/... M2



Allgemeine Vermaung

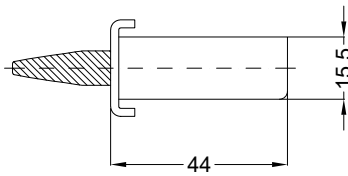

Frsmae

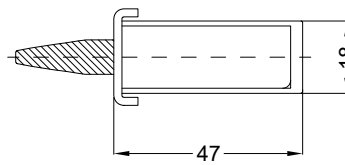

Situation
Schwenkriegel AP4

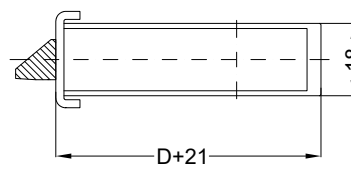
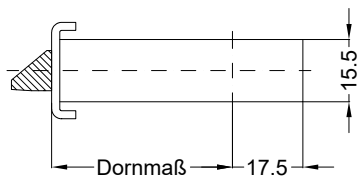

Situation
Falle
SK AP4

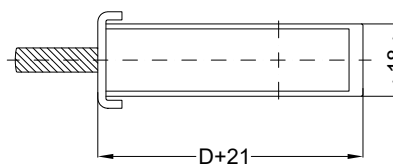
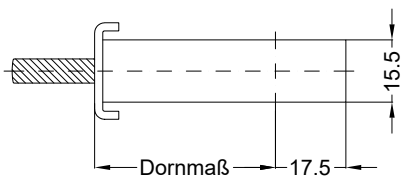

Situation
Riegel
SK AP4

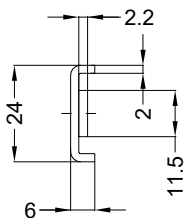

Lage
Schloss

Empfohlene Fräsung

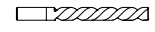

Ø 12

