

Ansichten
Schloss:

T-FG16175 .../D 92/... RT4

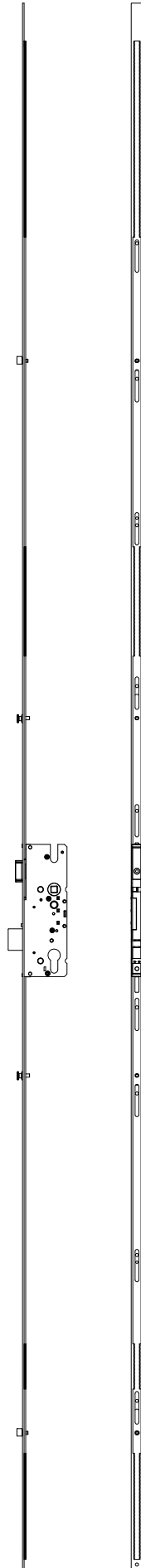

Technische Änderungen vorbehalten!

Fräsmaße
Schloss:

T-FG16175 .../D 92/... RT4

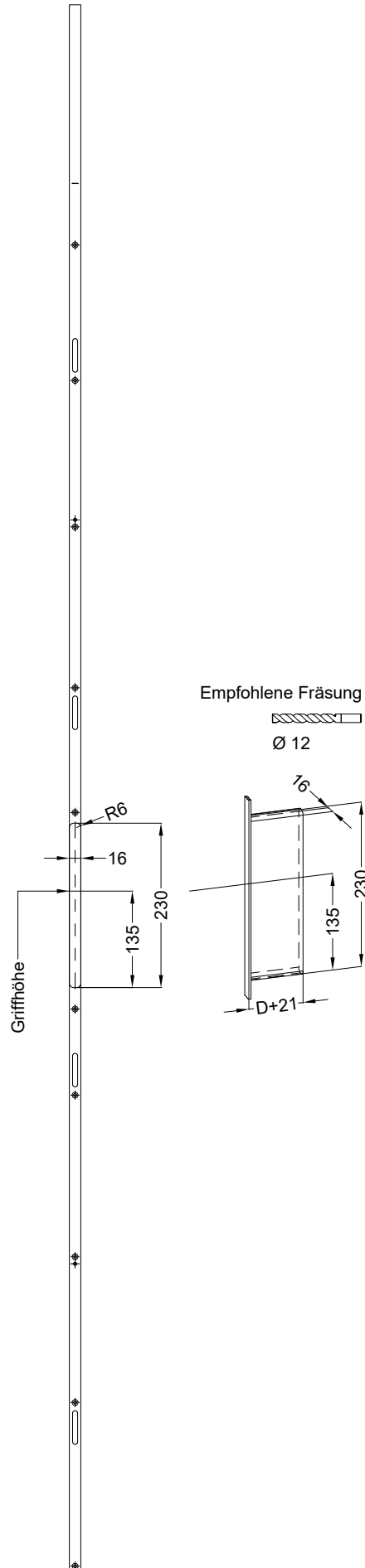

Allgemeine Vermaung

Frsmae

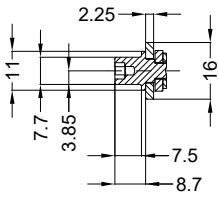

Situation
 Schliessbolzen
 Exzenter-schliebolzen SL

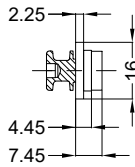

Situation
 Exzenterbolzen WK

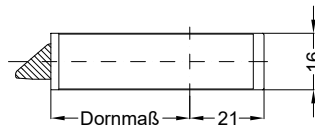
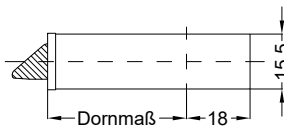

Situation
 Falle

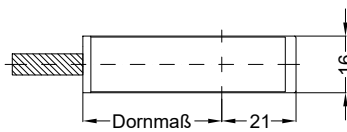
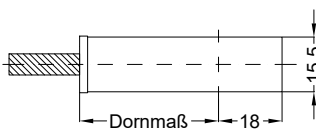

Situation
 Riegel

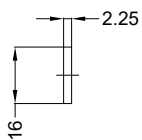

Lage
 Schloss

