

Perspektive  
Schloss:

T-AP4 E/B/D1 U2462 .../DS 92/... M2

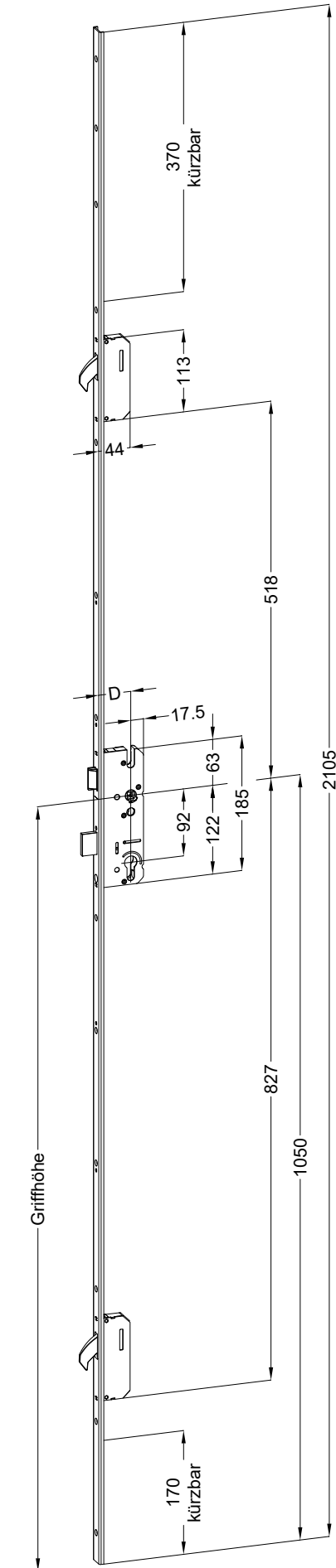

Technische Änderungen vorbehalten!

Schraublage  
Schloss:

T-AP4 E/B/D1 U2462 .../DS 92/... M2

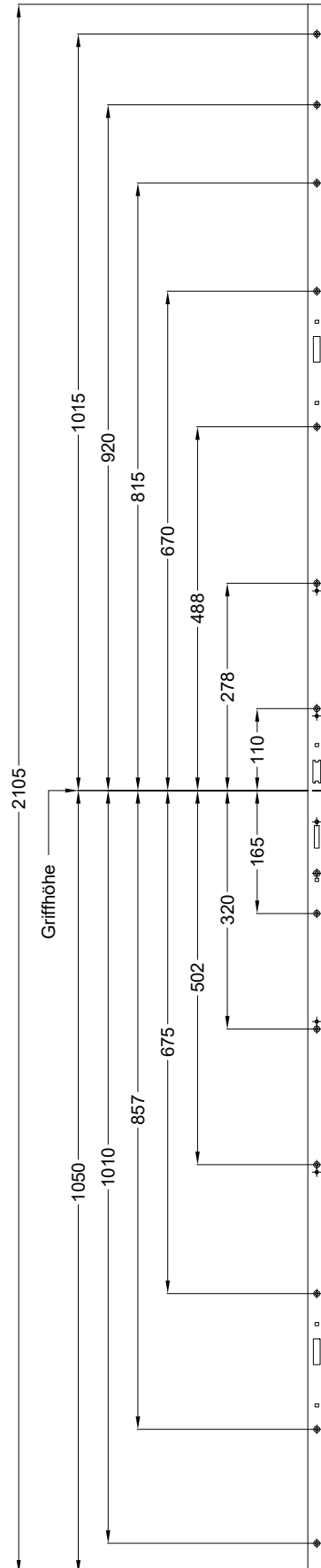
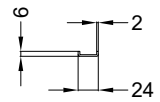

Technische Änderungen vorbehalten!

**Ansichten**  
**Schloss:**

**T-AP4 E/B/D1 U2462 .../DS 92/... M2**

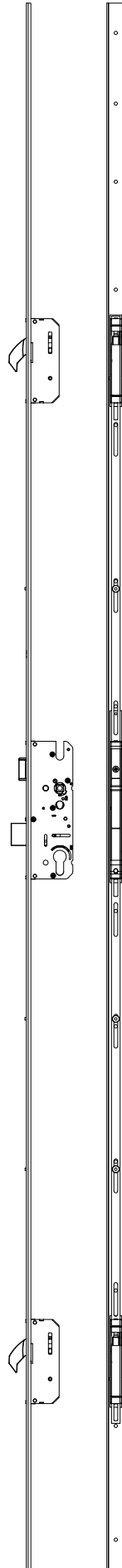

Technische Änderungen vorbehalten!



Allgemeine Vermaßung

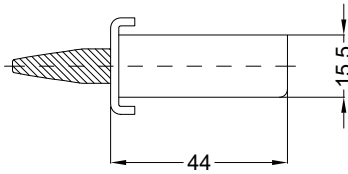

Fräsmaße

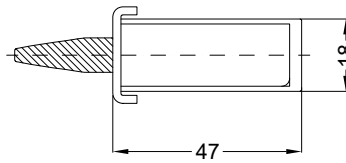

Situation  
 Schwenkriegel AP4

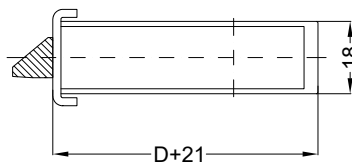
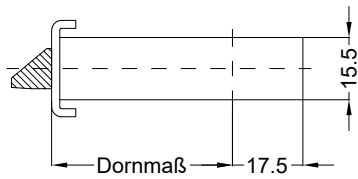

Situation  
 Falle  
 SK AP4

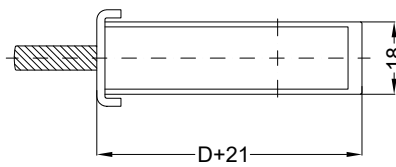
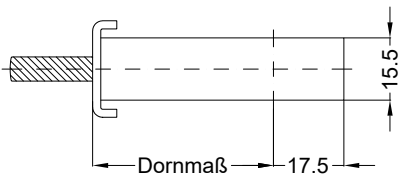

Situation  
 Riegel  
 SK AP4

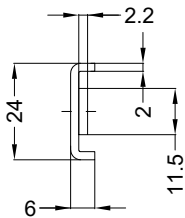

Lage  
 Schloss

