

Perspektive  
Schloss:

T-AV3-F2062 .../D A9 92/... M2 RS  
DIN LS spiegelbildlich

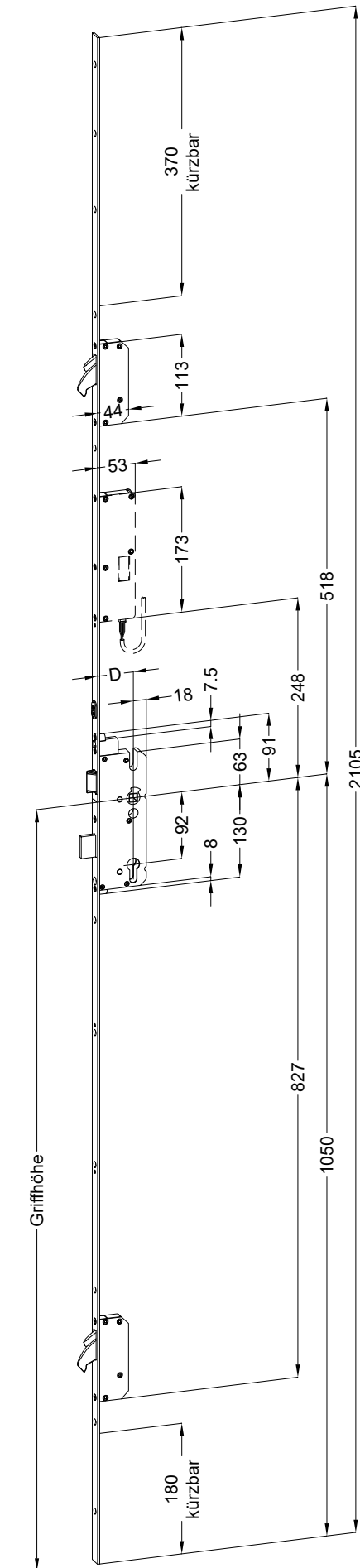

Technische Änderungen vorbehalten!

Schraublage  
Schloss:

T-AV3-F2062 .../D A9 92/... M2 RS  
DIN LS spiegelbildlich



Technische Änderungen vorbehalten!

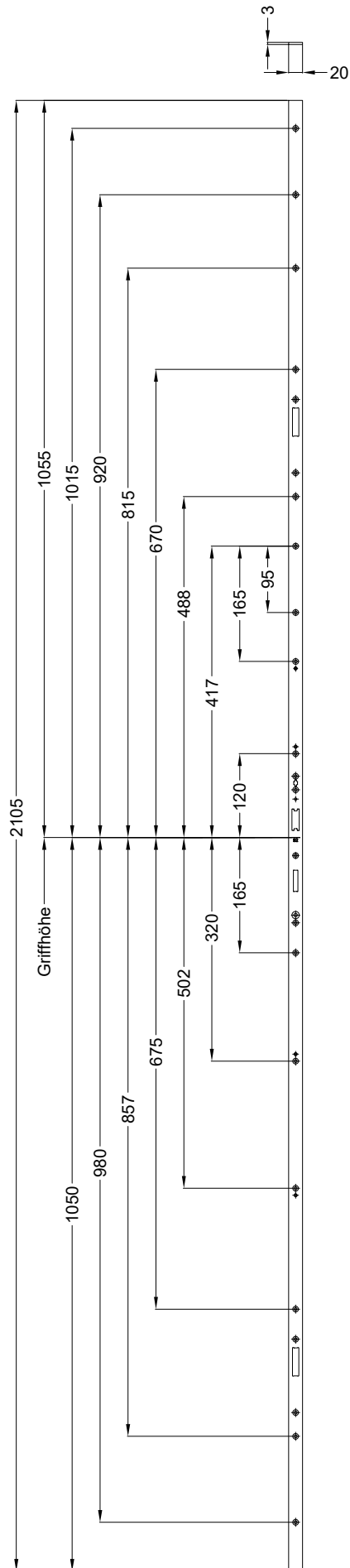

Ansichten  
Schloss:

T-AV3-F2062 .../D A9 92/... M2 RS  
DIN LS spiegelbildlich

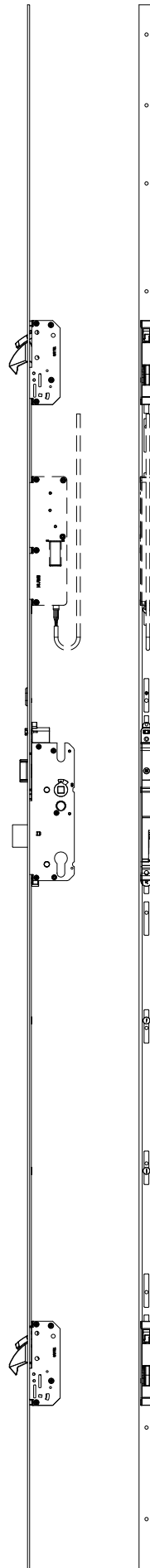

Technische Änderungen vorbehalten!



**Einbausituationen der Bauteile mit Fräsmaßen**  
**Schloss: T-AV3-F2062 .../D A9 92/... M2 RS**  
**DIN LS spiegelbildlich**



**Allgemeine Vermaung**

**Frsmae**

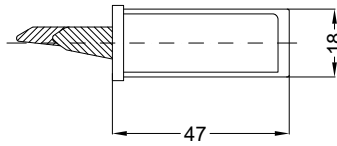
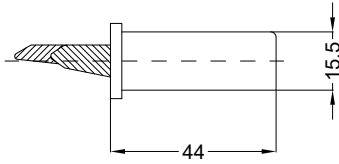

Situation  
 Schwenkriegel  
 TM AV3 SK RS

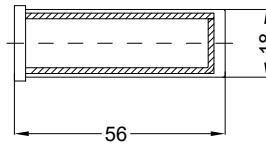
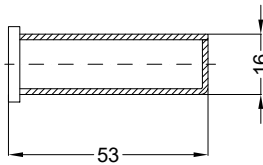

Situation  
 Motorkasten EAV

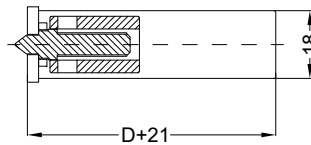
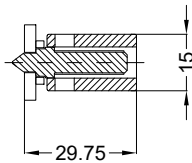

Situation  
 Taststift  
 SK AV3

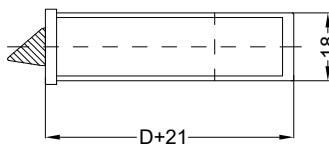
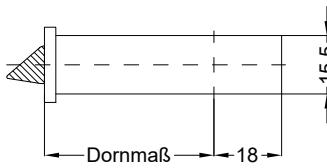

Situation  
 Falle  
 SK AV3

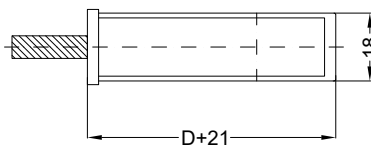
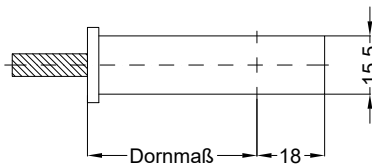

Situation  
 Riegel  
 SK AV3

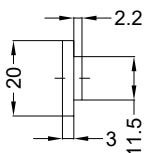

Lage  
 Schloss

Katalogdarstellung

Schloss: T-AV3-F2062 .../D A9 92/... M2 RS  
DIN LS spiegelbildlich

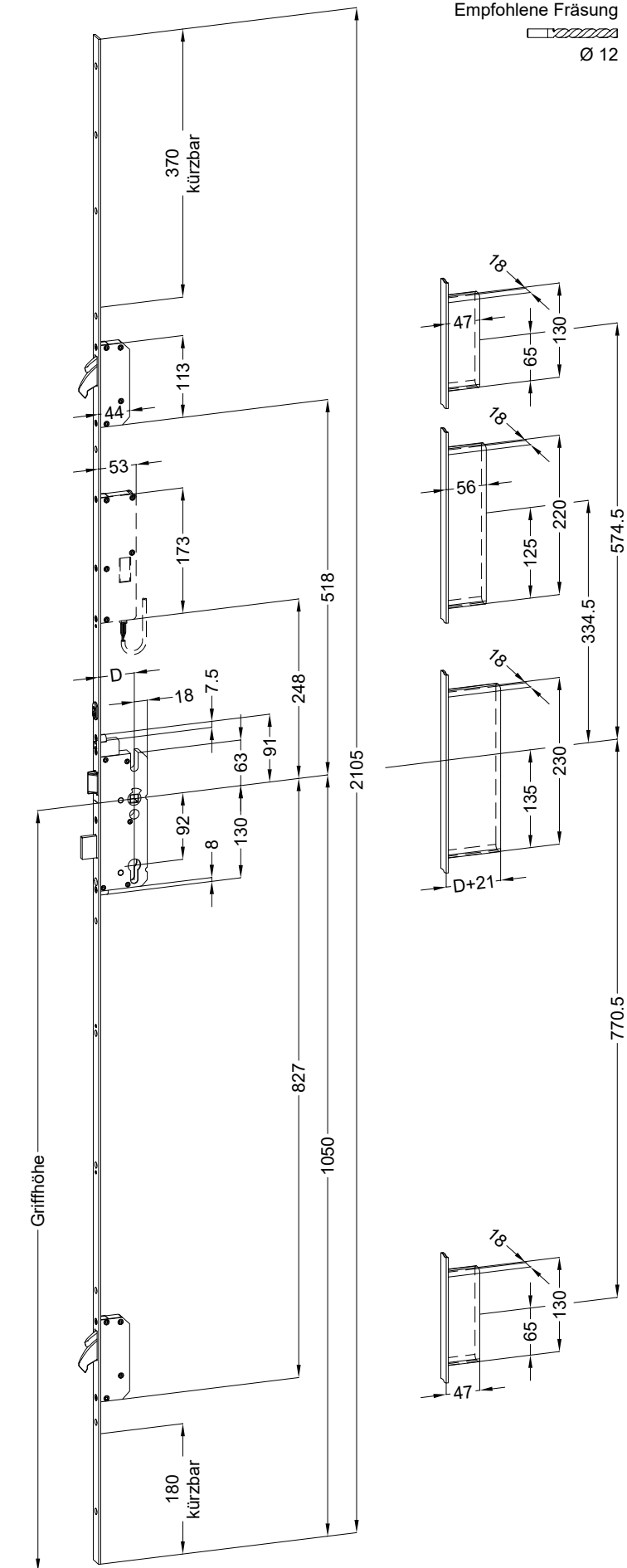

Technische Änderungen vorbehalten!