

Perspektive  
Schloss:

T-AV3-U247169 .../D A9 92/... M2 RS  
DIN LS spiegelbildlich

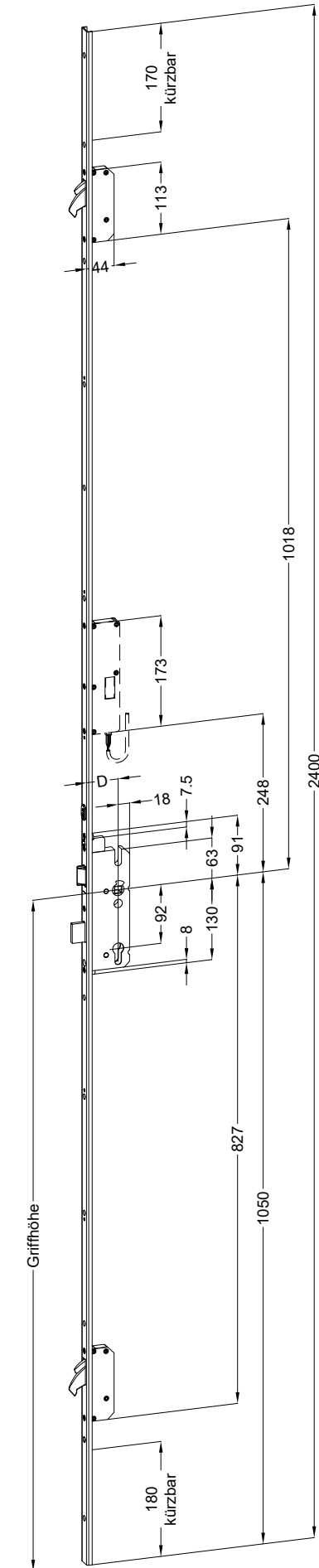

Technische Änderungen vorbehalten!



**Ansichten**  
**Schloss:**

**T-AV3-U247169 .../D A9 92/... M2 RS**  
**DIN LS spiegelbildlich**

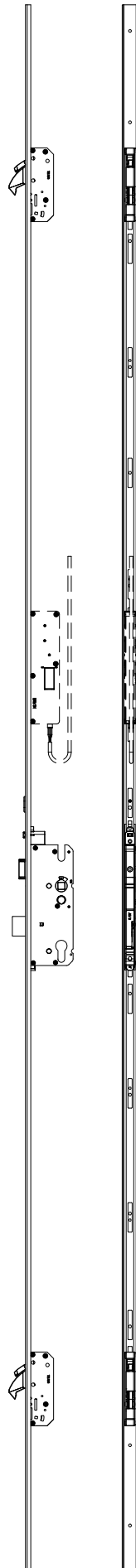



**Einbausituationen der Bauteile mit Fräsmaßen**

**Schloss: T-AV3-U247169 .../D A9 92/... M2 RS  
DIN LS spiegelbildlich**



**Allgemeine Vermaung**

**Frsmae**

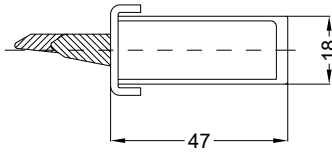
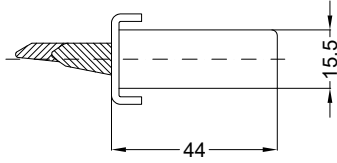

Situation  
Schwenkriegel  
TM AV3 SK RS

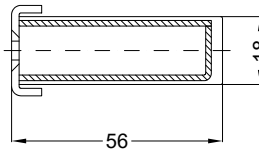
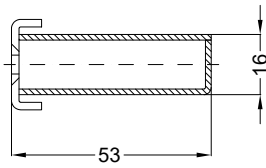

Situation  
Motorkasten EAV

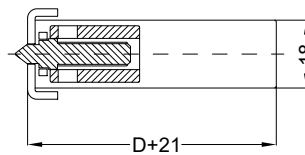
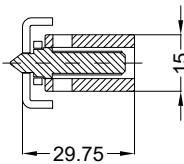

Situation  
Taststift  
SK AV3

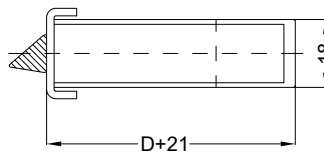
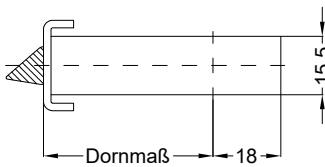

Situation  
Falle  
SK AV3

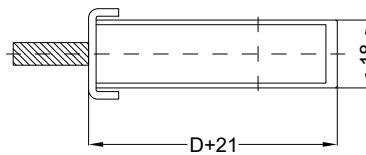
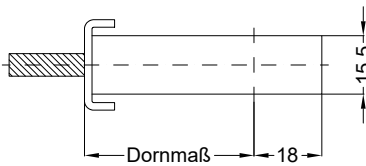

Situation  
Riegel  
SK AV3

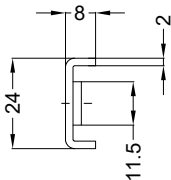

Lage  
Schloss

Katalogdarstellung

Schloss: T-AV3-U247169 .../D A9 92/... M2 RS  
DIN LS spiegelbildlich



Technische Änderungen vorbehalten!

