

Perspektive  
Schloss:

T-AV3-F2460 .../D A9 94/... KABA M2 RS  
DIN LS spiegelbildlich

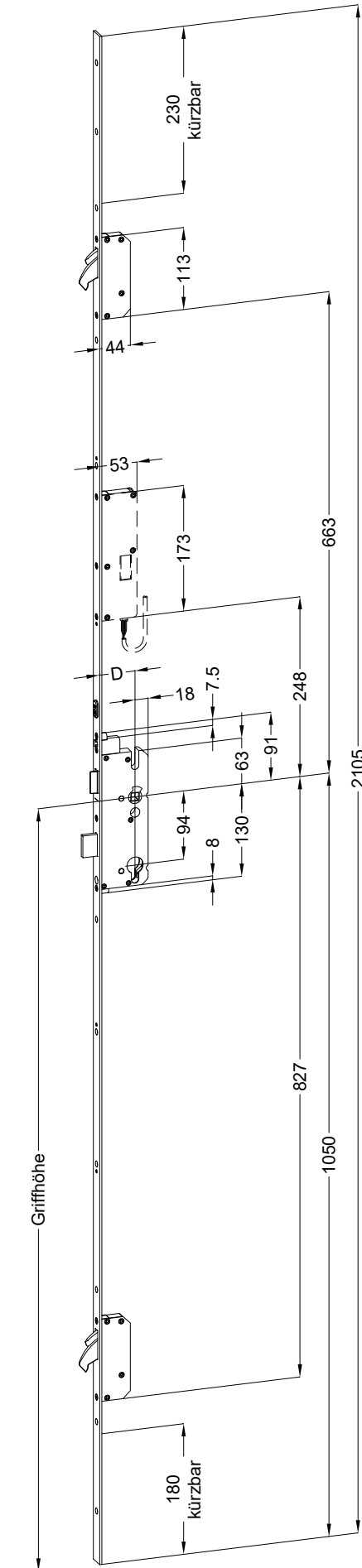

Technische Änderungen vorbehalten!

Schraublage  
Schloss:

T-AV3-F2460 .../D A9 94/... KABA M2 RS  
DIN LS spiegelbildlich

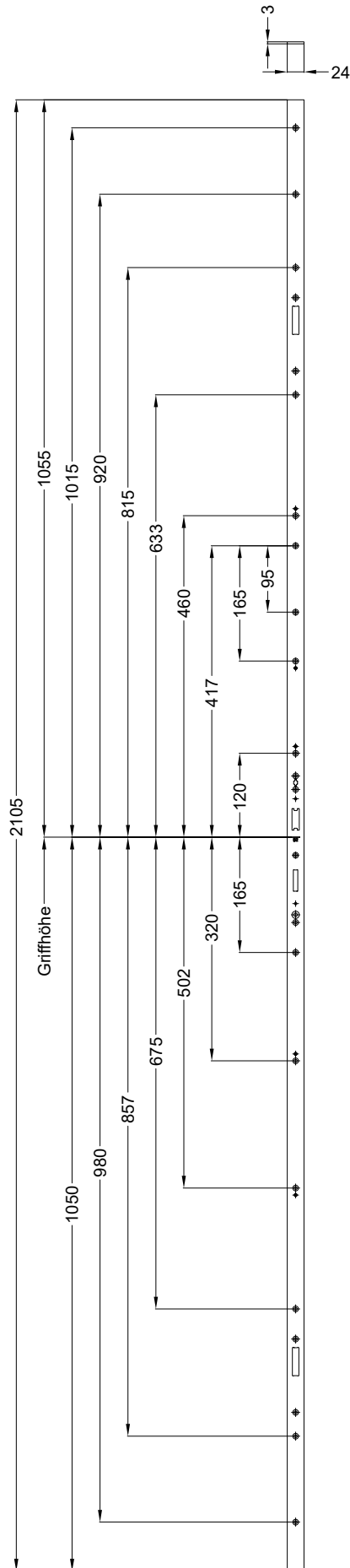

Technische Änderungen vorbehalten!

**Ansichten**  
**Schloss:**

**T-AV3-F2460 .../D A9 94/... KABA M2 RS**  
**DIN LS spiegelbildlich**

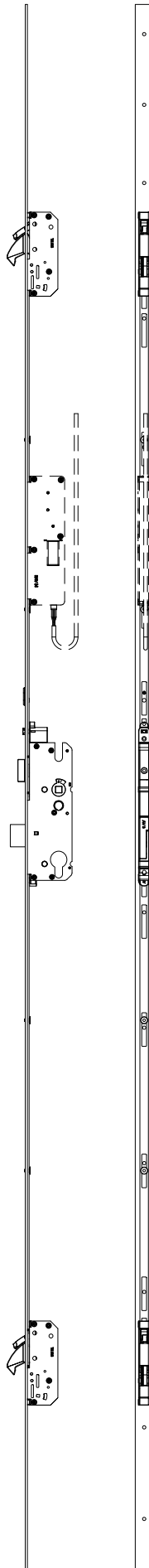



Einbausituationen der Bauteile mit Fräsmaßen

Schloss: T-AV3-F2460 .../D A9 94/... KABA M2 RS  
DIN LS spiegelbildlich



Allgemeine Vermaßung

Fräsmaße

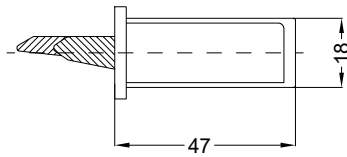
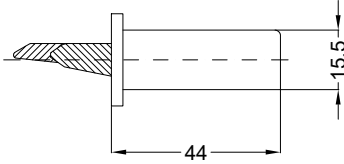

Situation  
Schwenkriegel  
TM AV3 SK RS

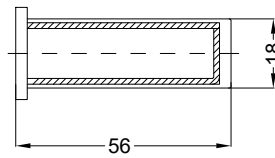
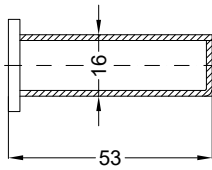

Situation  
Motorkasten EAV

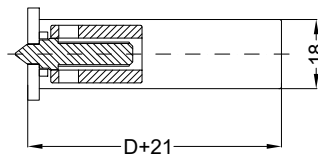
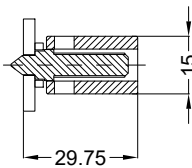

Situation  
Taststift  
SK AV3

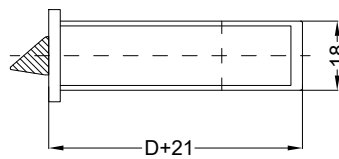
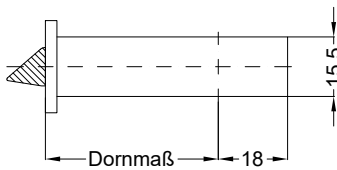

Situation  
Falle  
SK AV3

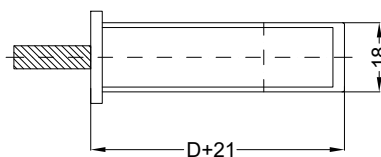
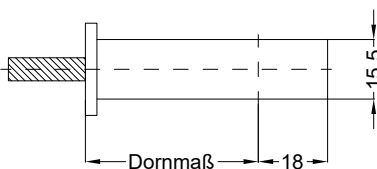

Situation  
Riegel  
SK AV3

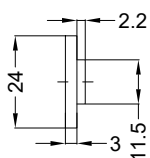

Lage  
Schloss

Katalogdarstellung

Schloss: T-AV3-F2460 .../D A9 94/... KABA M2 RS  
DIN LS spiegelbildlich

