

Perspektive
Schloss:

T-AV3-U2294 .../D A9 92/... M2 RS
DIN LS spiegelbildlich

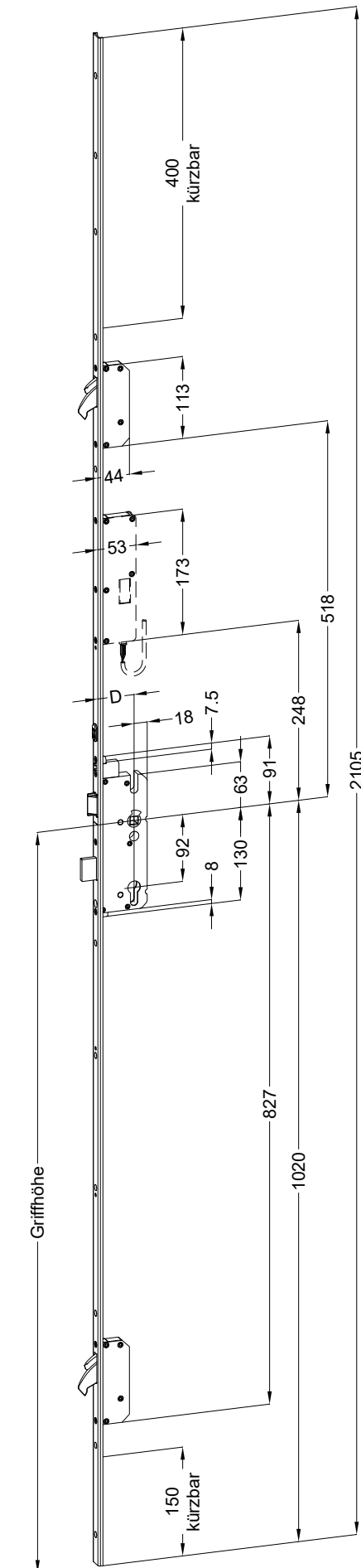

Technische Änderungen vorbehalten!

Schraublage
Schloss:

T-AV3-U2294 .../D A9 92/... M2 RS
DIN LS spiegelbildlich

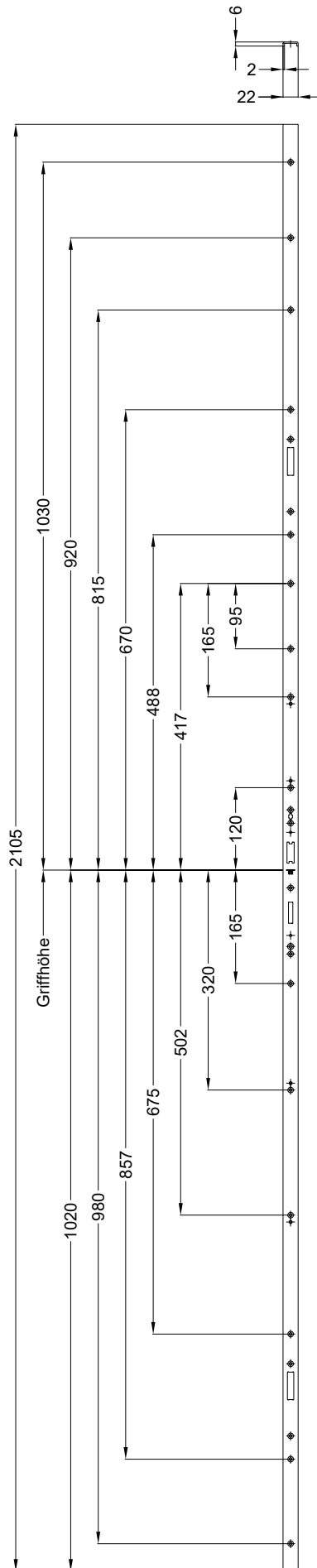

Ansichten
Schloss:

T-AV3-U2294 .../D A9 92/... M2 RS
DIN LS spiegelbildlich

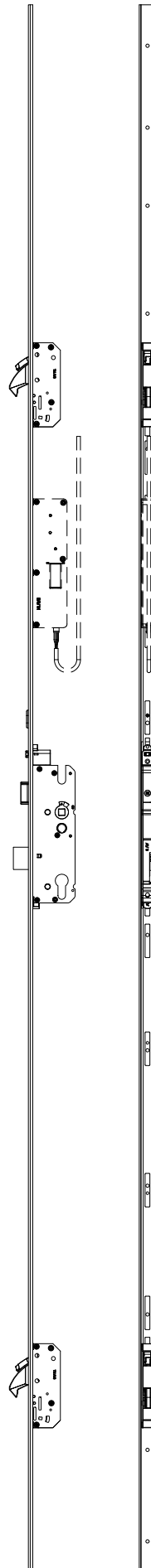

Technische Änderungen vorbehalten!

Einbausituationen der Bauteile mit Fräsmaßen
Schloss: T-AV3-U2294 .../D A9 92/... M2 RS
DIN LS spiegelbildlich



Allgemeine Vermaung

Frsmae

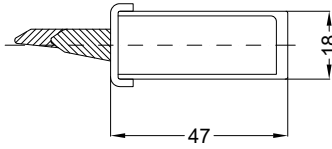
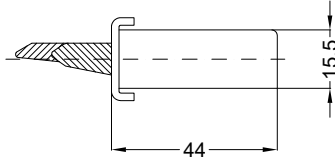

Situation
 Schwenkriegel
 TM AV3 SK RS

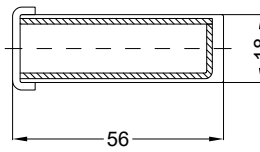
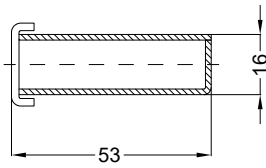

Situation
 Motorkasten EAV

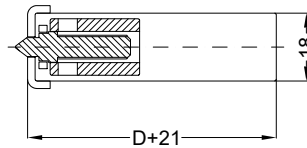
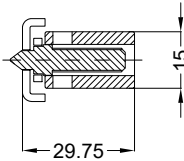

Situation
 Taststift
 SK AV3

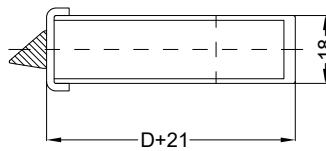
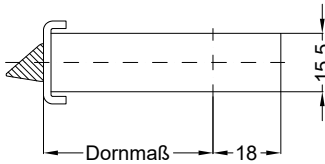

Situation
 Falle
 SK AV3

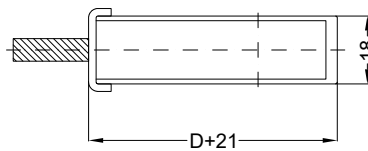
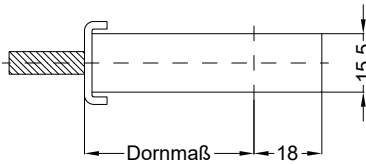

Situation
 Riegel
 SK AV3

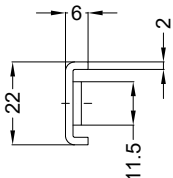

Lage
 Schloss

Katalogdarstellung

Schloss: T-AV3-U2294 .../D A9 92/... M2 RS
DIN LS spiegelbildlich



Technische Änderungen vorbehalten!

