

Perspektive
Schloss:

T-U2469 .../D 92/... M2

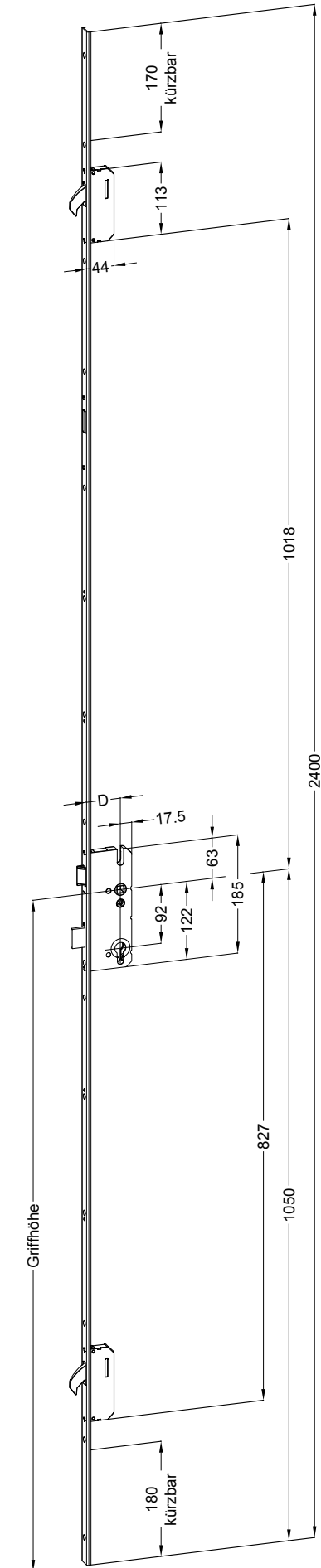

Technische Änderungen vorbehalten!



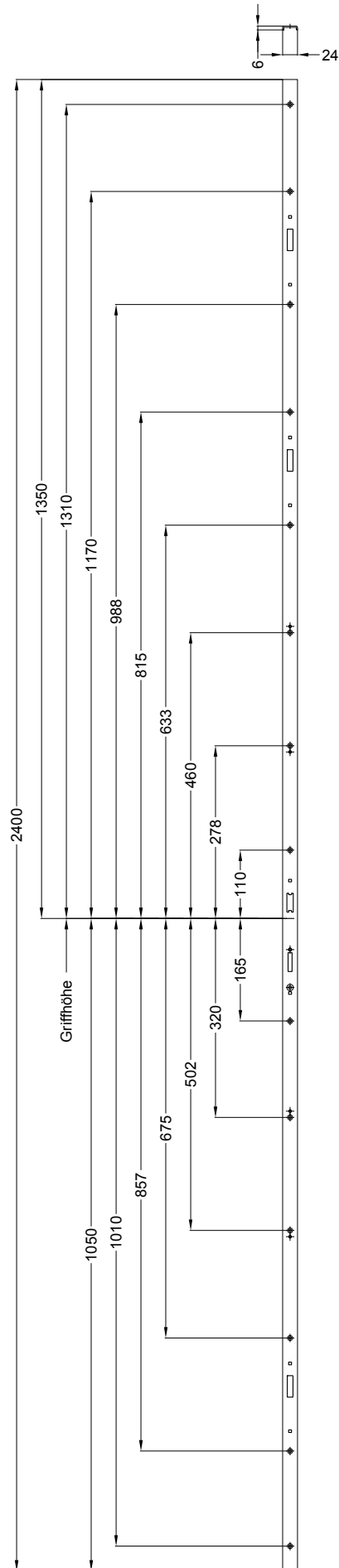

Ansichten
Schloss:

T-U2469 .../D 92/... M2

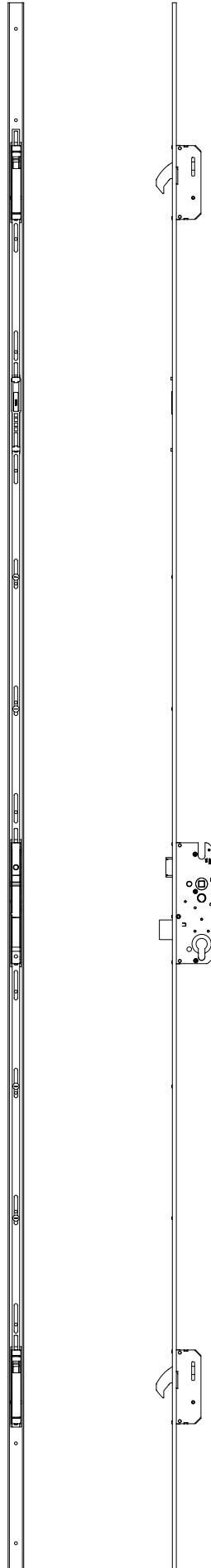

Technische Änderungen vorbehalten!

Allgemeine Vermaung

Frsmae

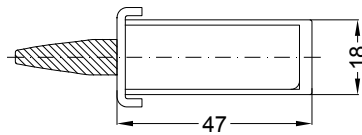
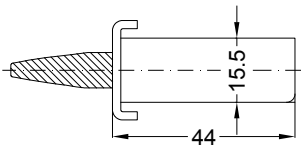

Situation
Schwenkriegel
TM6 Y2K

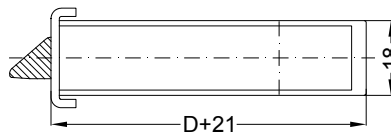
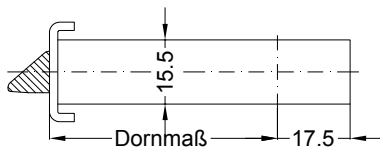

Situation
Falle

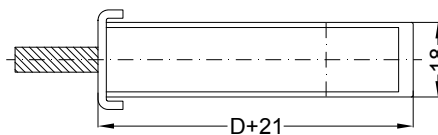
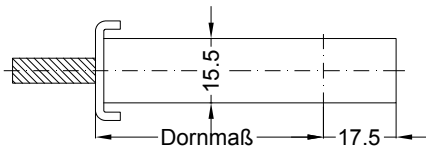

Situation
Riegel

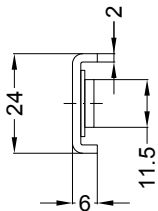

Lage
Schloss

Technische Änderungen vorbehalten!

