

Perspektive
Schloss:

T-AV3-U2460 .../D A9 92/... M4 RS
DIN LS spiegelbildlich

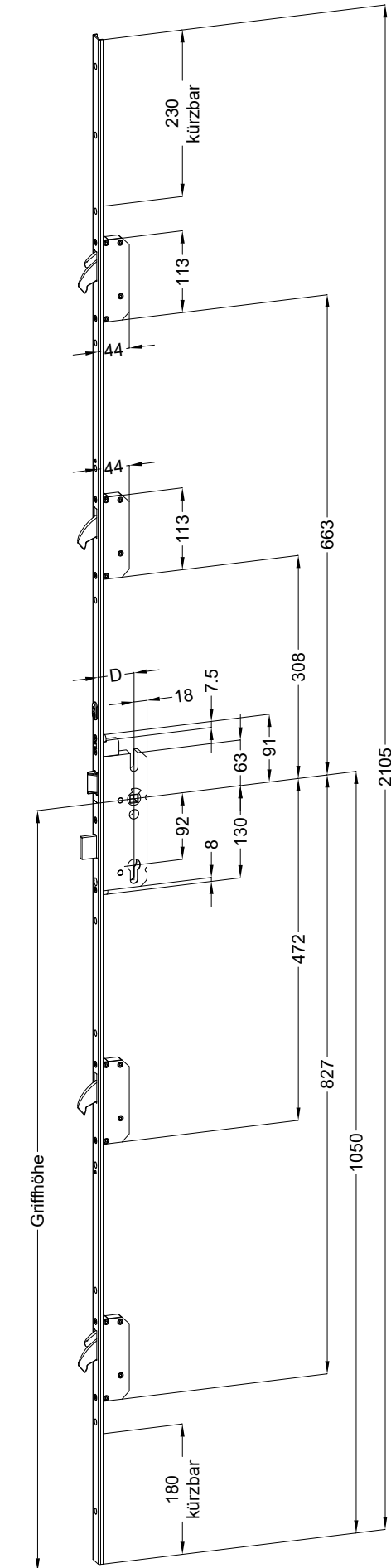

Technische Änderungen vorbehalten!

Schraublage
Schloss:

T-AV3-U2460 .../D A9 92/... M4 RS
DIN LS spiegelbildlich

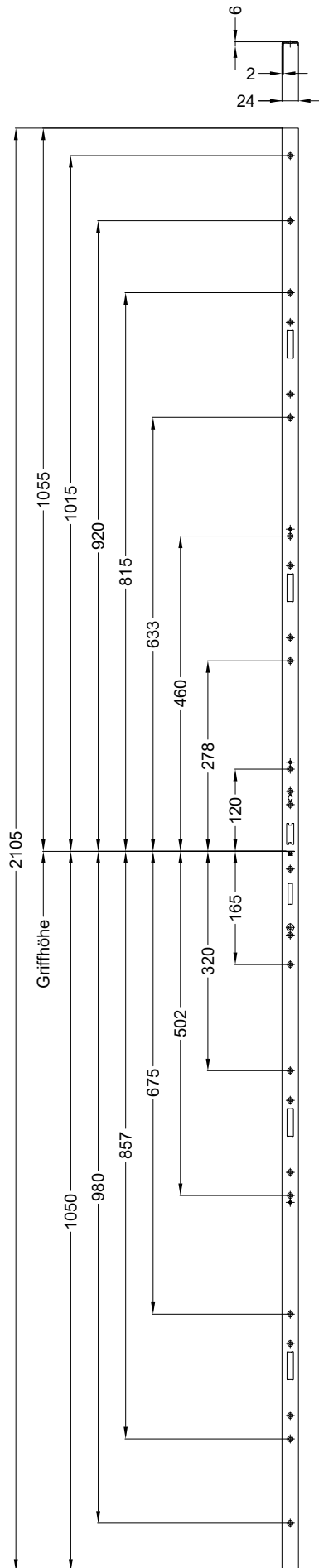

Ansichten
Schloss:

T-AV3-U2460 .../D A9 92/... M4 RS
DIN LS spiegelbildlich

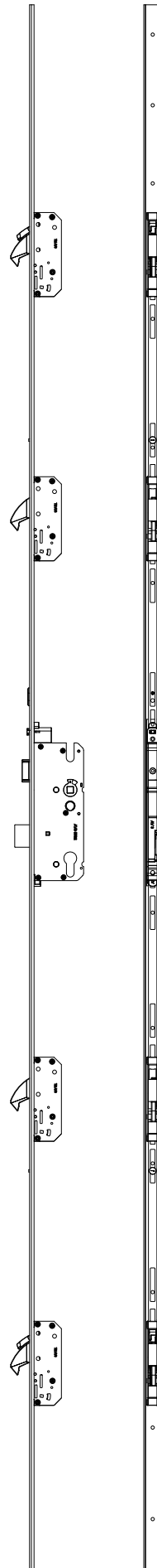

Technische Änderungen vorbehalten!

Fräsmaße
Schloss:

T-AV3-U2460 .../D A9 92/... M4 RS
DIN LS spiegelbildlich

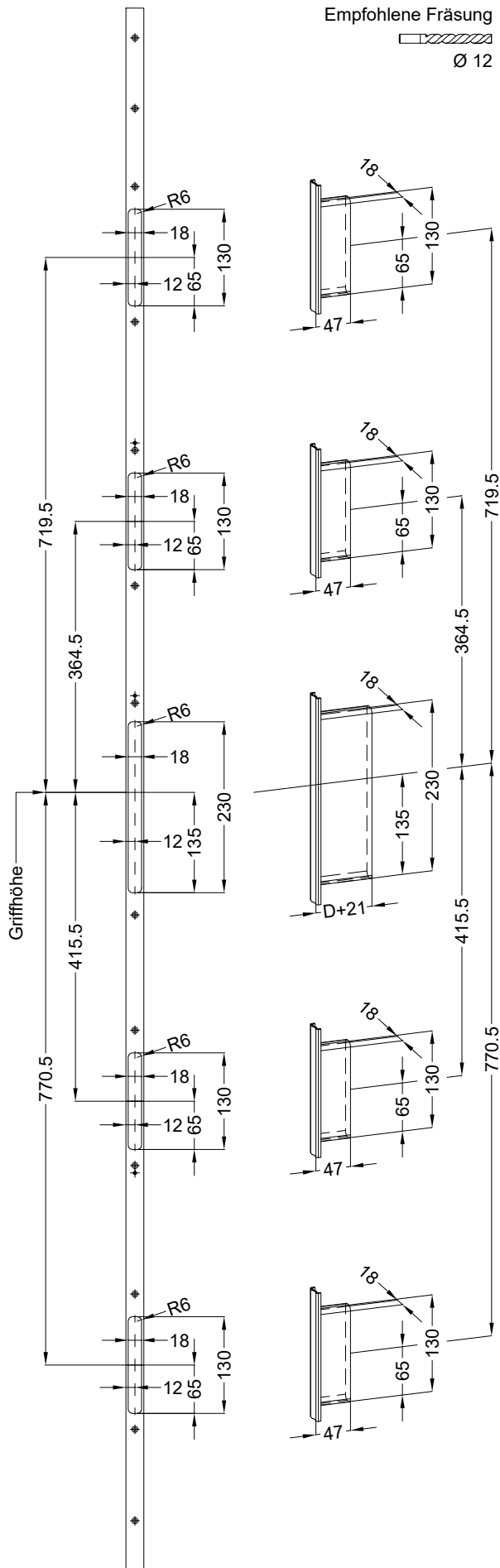

Einbausituationen der Bauteile mit Fräsmaßen
Schloss: T-AV3-U2460 .../D A9 92/... M4 RS
DIN LS spiegelbildlich



Allgemeine Vermaßung

Fräsmaße

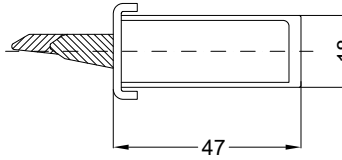
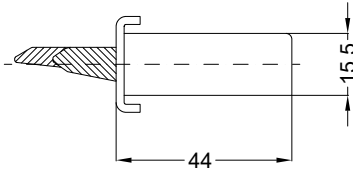

Situation
 Schwenkriegel
 TM AV3 SK RS

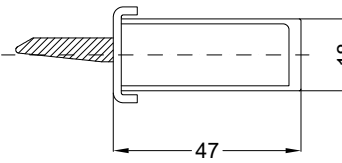
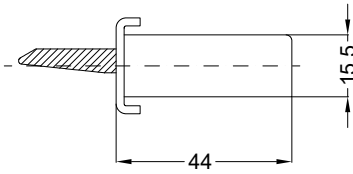

Situation
 Schwenkriegel
 TM AV3 SK OAR

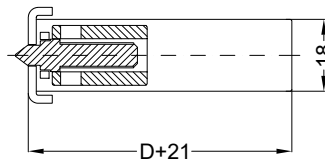
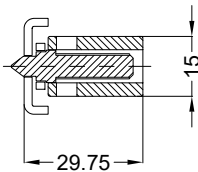

Situation
 Taststift
 SK AV3

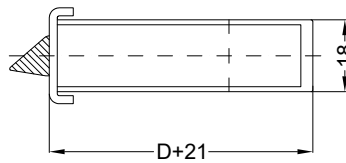
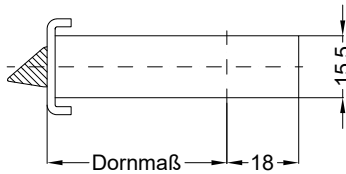

Situation
 Falle
 SK AV3

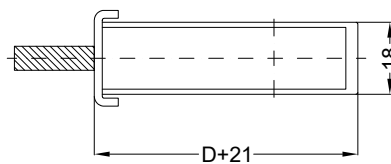
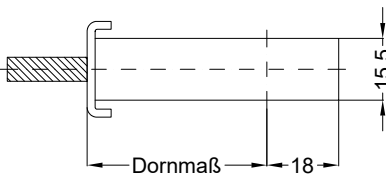

Situation
 Riegel
 SK AV3

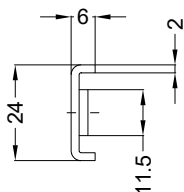

Lage
 Schloss

Katalogdarstellung

Schloss: T-AV3-U2460 .../D A9 92/... M4 RS
DIN LS spiegelbildlich

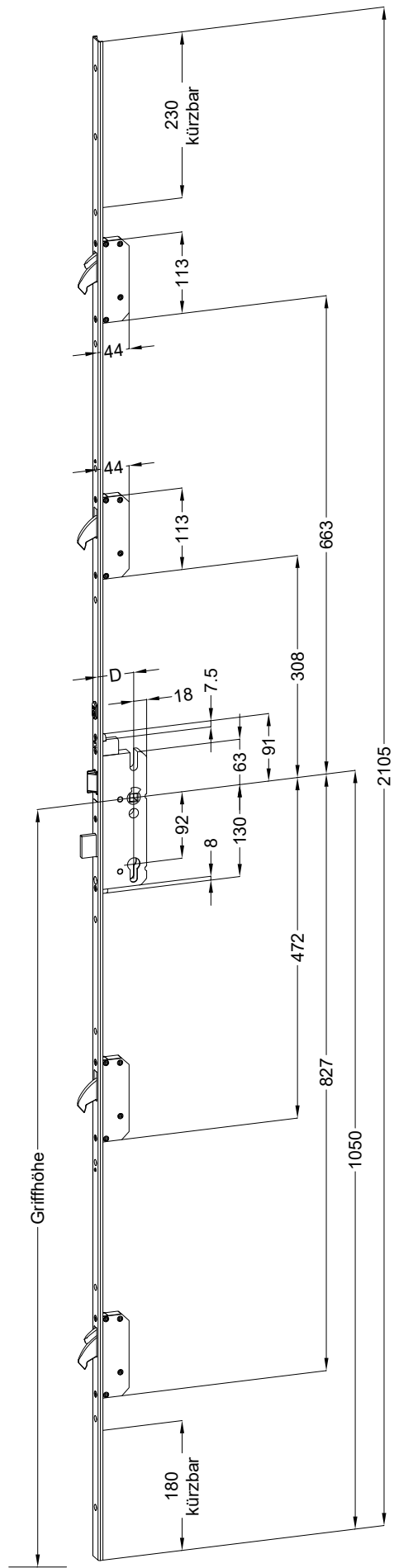

Empfohlene Fräsung

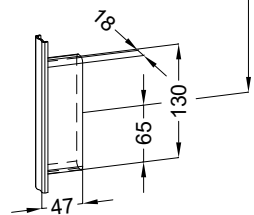
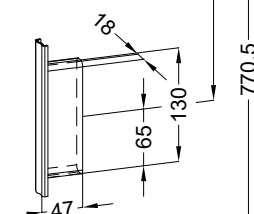
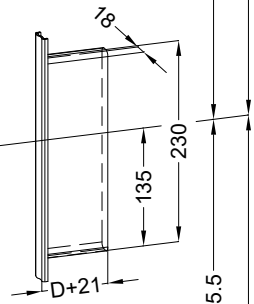
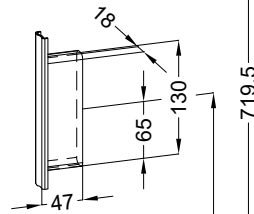
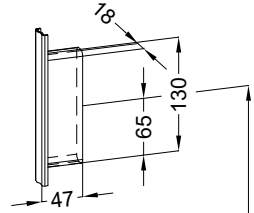
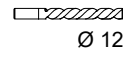

719.5

364.5

230

770.5