



Most Widely Accepted and Trusted

ICC-ES Evaluation Report

ESR-1990

ICC-ES | (800) 423-6587 | (562) 699-0543 | www.icc-es.org

Reissued 09/2017
This report is subject to renewal 09/2019.

DIVISION: 03 00 00—CONCRETE

SECTION: 03 16 00—CONCRETE ANCHORS

DIVISION: 05 00 00—METALS

SECTION: 05 05 19—POST-INSTALLED CONCRETE ANCHORS

REPORT HOLDER:

fischerwerke GmbH & Co. KG

**KLAUS-FISCHER-STRASSE 1
72178 WALDACHTAL
GERMANY**

EVALUATION SUBJECT:

**fischer FIS EM ADHESIVE ANCHORING SYSTEM
FOR CRACKED AND UNCRACKED CONCRETE**



Look for the trusted marks of Conformity!

“2014 Recipient of Prestigious Western States Seismic Policy Council (WSSPC) Award in Excellence”



A Subsidiary of

ICC-ES Evaluation Reports are not to be construed as representing aesthetics or any other attributes not specifically addressed, nor are they to be construed as an endorsement of the subject of the report or a recommendation for its use. There is no warranty by ICC Evaluation Service, LLC, express or implied, as to any finding or other matter in this report, or as to any product covered by the report.



ICC-ES Evaluation Report

ESR-1990

Reissued September 2017

Revised November 2017

This report is subject to renewal September 2019.

www.icc-es.org | (800) 423-6587 | (562) 699-0543

A Subsidiary of the International Code Council®

DIVISION: 03 00 00—CONCRETE

Section: 03 16 00—Concrete Anchors

DIVISION: 05 00 00—METALS

Section: 05 05 19—Post-Installed Concrete Anchors

REPORT HOLDER:

fischerwerke GmbH & Co. KG

KLAUS-FISCHER-STRASSE 1

72178 WALDACHTAL

GERMANY

+49 7443 120

www.fischerwerke.de

EVALUATION SUBJECT:

fischer FIS EM ADHESIVE ANCHORING SYSTEM FOR
CRACKED AND UNCRACKED CONCRETE

1.0 EVALUATION SCOPE

Compliance with the following codes:

- 2015, 2012, 2009 and 2006 *International Building Code*® (IBC)
- 2015, 2012, 2009 and 2006 *International Residential Code*® (IRC)

Property evaluated:

Structural

2.0 USES

Adhesive anchors installed using the fischer FIS EM Adhesive Anchoring System are post-installed adhesive anchors used to resist static, wind and earthquake (IBC Seismic Design Categories A through F) tension and shear loads in cracked and uncracked normal-weight concrete having a specified compressive strength, f'_c , of 2,500 psi to 8,500 psi (17.2 MPa to 58.6 MPa).

The anchoring system complies with the requirements for anchors as described in Section 1901.3 of the 2015 IBC, Section 1909 of the 2012 IBC and is an alternative to cast-in-place and post-installed anchors described in Sections 1908 of the 2012 IBC, and Sections 1911 and 1912 of the 2009 and 2006 IBC. The anchor systems may also be used where an engineered design is submitted in accordance with Section R301.1.3 of the IRC.

3.0 DESCRIPTION

3.1 General:

The fischer FIS EM Adhesive Anchor System is comprised of the following components:

- Adhesive packaged in cartridges: fischer FIS EM 390 S or fischer FIS EM 585 S, and fischer FIS EM 390 S Plus or fischer FIS EM 585 S Plus,
- Adhesive mixing and dispensing equipment
- Equipment for hole cleaning and adhesive injection
- An anchor element (continuously threaded steel rod or a deformed steel reinforcing bar)

fischer FIS EM adhesive may only be used with continuously threaded steel rods or deformed steel reinforcing bars described in Tables 2, 3, and 4 of this report. The primary components of the fischer adhesive anchor system, including the fischer FIS EM Adhesive, static mixer and 2 anchoring elements are shown in Figure 3 of this report.

The manufacturer's printed installation instructions (MPII), as included with each adhesive unit package, are shown in Figure 5 of this report. The adhesive is also referred to as "mortar" in the installation instructions.

3.2 Materials:

3.2.1 fischer FIS EM Adhesive: fischer FIS EM Adhesive, also available labeled as the fischer FIS EM Plus Adhesive, is an injectable, epoxy adhesive. The two components are kept separate in a dual-chambered cartridge. The two components combine and react when dispensed through a static mixing nozzle attached to the manifold. The system is labeled fischer FIS EM 390 S (Plus) [13.2 oz (390 mL)] or fischer FIS EM 585 S (Plus) [19.8 oz. (585 mL)]. In this report, both cartridge sizes, with or without the "Plus" designation, are denoted as fischer FIS EM. The cartridge is stamped with the adhesive expiration date. The shelf life, as indicated by the expiration date, corresponds to an unopened pack stored in a dry, dark environment. Storage temperature of the adhesive is 41°F to 86°F (5°C to 30°C). Short-term (less than 48-hour) temperature variations during adhesive storage are permitted as long as the temperature remains between 41°F and 104°F (5°C and 40°C). Under these conditions the shelf life is 36 months.

3.2.2 Hole Cleaning Equipment and Installation Accessories: Hole cleaning equipment comprised of steel wire brushes and air nozzles must be used in accordance with Figure 5 of this report. Installation accessories include static mixing nozzles, extension tubes, and injection adapters as depicted in Figure 5 of this report.

3.2.3 Dispensers: fischer FIS EM adhesive must be dispensed with manual dispensers, cordless electric

dispensers or pneumatic dispensers provided by fischerwerke.

3.2.4 Steel Anchor Elements:

3.2.4.1 Standard Threaded steel rods: Threaded steel rods must be clean, continuously threaded rods (all-thread) in diameters as described in Tables 5 and 11 of this report. Steel design information for common grades of threaded rod and associated nuts are provided in Table 2 and Table 3 of this report. Carbon steel threaded rods are furnished with a 0.0002-inch-thick (0.005 mm) zinc electroplated coating in accordance with ASTM B633 SC 1, or must be hot-dipped galvanized in accordance with ASTM A153, Class C or D. Steel grade and type (carbon, stainless) for nuts and washers must correspond to the threaded steel rod. Threaded steel rods must be straight and free of indentations or other defects along their length. The end may be stamped with identifying marks and the embedded end may be blunt cut or cut on the bias (chisel point).

3.2.4.2 fisher Threaded Steel Rods FIS A and RG M: fisher FIS A and RG M anchor rods are threaded rods. The fisher FIS A is a threaded rod with flat shape on both end. The fisher RG M is a threaded rod with a chamfer shape on the embedded section and flat or hexagonal end on the concrete surface side, as shown in Tables 2 and 3 and Figure 4. Mechanical properties for the fisher FIS A and RG M are provided in Tables 2 and 3 of this report. The anchor rods are available in diameters as shown in Table 5. fisher FIS A and RG M anchor rods are produced from carbon steel and furnished with a 0.0002-inch-thick (0.005 mm) zinc electroplated coating or fabricated from stainless steel. Steel grade and type (carbon, stainless) for the washers and nuts must match the threaded rods. The threaded rods are marked on the head with an identifying mark (see Figure 4).

3.2.4.3 Steel Reinforcing bars: Steel reinforcing bars are deformed reinforcing bars as described in Table 4 of this report. Tables 8 and 14 summarize reinforcing bar size ranges. The embedded portions of reinforcing bars must be straight, and free of mill scale, rust, mud, oil and other coatings that impair the bond with the adhesive. Reinforcing bars must not be bent after installation, except as set forth in ACI 318-14 Section 26.6.3.1 (b) or ACI 318-11 Section 7.3.2, as applicable, with the additional condition that the bars must be bent cold, and heating of reinforcing bars to facilitate field bending is not permitted.

3.2.4.4 Ductility of Anchor Elements: In accordance with ACI 318-14 2.3 or ACI 318-11 D.1, as applicable, in order for a steel element to be considered ductile, the tested elongation must be at least 14 percent and reduction of area must be at least 30 percent. Steel elements with a tested elongation of less than 14 percent or a reduction of area of less than 30 percent, or both, are considered brittle. Values for various steel materials are provided in Tables 2, 3 and 4 of this report. Where values are nonconforming or unstated, the steel must be considered brittle.

3.3 Concrete:

Normal-weight concrete must comply with Sections 1903 and 1905 of the IBC. The specified compressive strength of the concrete must be from 2,500 psi to 8,500 psi (17.2 MPa to 58.6 MPa).

4.0 DESIGN AND INSTALLATION

4.1 Strength Design:

4.1.1 General: The design strength of adhesive anchors under the 2015 IBC, as well as the 2015 IRC, must be determined in accordance with ACI 318-14 and this report. The design strength of adhesive anchors under the 2012, 2009 and 2006 IBC, as well as the 2012, 2009 and 2006 IRC, must be determined in accordance with ACI 318-11 and this report.

Design parameters are based on ACI 318-14 for use with 2015 IBC or ACI 318-11 for use with the 2012, 2009 and 2006 IBC, as applicable, unless noted otherwise in Sections 4.1.1 through 4.1.11 of this report. Table 1 provides an index to the design strengths.

The strength design of adhesive anchors must comply with ACI 318-14 17.3.1 or 318-11 D.4.1, as applicable, except as required in ACI 318-14 17.2.3 or 318-11 D.3.3, as applicable.

Design parameters are provided in Tables 5 through 16 of this report. Strength reduction factors, ϕ , as described in ACI 318-14 17.3.3 or ACI 318-11 D.4.3, as applicable, must be used for load combinations calculated in accordance with Section 1605.2 of the IBC, ACI 318-14 5.3 or ACI 318-11 9.2, as applicable. Strength reduction factors, ϕ , as described in ACI 318-11 D.4.4 must be used for load combinations calculated in accordance with ACI 318-11 Appendix C.

4.1.2 Static Steel Strength in Tension: The nominal steel strength of a single anchor in tension, N_{sa} , shall be calculated in accordance with ACI 318-14 17.4.1.2 or ACI 318-11 D.5.1.2, as applicable, and the associated strength reduction factors, ϕ , in accordance with ACI 318-14 17.3.3 or ACI 318-11 D.4.3, as applicable, are given in Tables 5, 8, 11 and 14 of this report for the anchor element types included in this report. See Table 1.

4.1.3 Static Concrete Breakout Strength in Tension: The nominal static concrete breakout strength in tension of a single anchor or group of anchors, N_{cb} or N_{cbg} , must be calculated in accordance with ACI 318-14 17.4.2 or ACI 318-11 D.5.2, as applicable, with the following addition:

The basic concrete breakout strength of a single anchor in tension, N_b , must be calculated in accordance with ACI 318-14 17.4.2.2 or ACI 318-11 D.5.2.2, as applicable, using the values of $k_{c,cr}$ and $k_{c,uncr}$ as described in the tables of this report. Where analysis indicates no cracking in accordance with ACI 318-14 17.4.2.6 or ACI 318-11 D.5.2.6, as applicable, N_b must be calculated using $k_{c,uncr}$ and $\psi_{c,N} = 1.0$. See Table 1. For anchors in lightweight concrete see ACI 318-14 17.2.6 or ACI 318-11 D.3.6, as applicable. The value of f'_c used for calculation must be limited to 8,000 psi (55 MPa) in accordance with ACI 318-14 17.2.7 or ACI 318-11 D.3.7, as applicable. Additional information for the determination of nominal bond strength in tension is given in Section 4.1.4 of this report.

4.1.4 Static Bond Strength in Tension: The nominal static bond strength of a single adhesive anchor or group of adhesive anchors in tension, N_a or N_{ag} , must be calculated in accordance with ACI 318-14 17.4.5 or ACI 318-11 D.5.5, as applicable. Bond strength values are a function of the concrete compressive strength, whether the concrete is cracked or uncracked, the concrete temperature range, and the installation conditions (dry or water-saturated concrete). The resulting characteristic bond strength shall be multiplied by the associated strength reduction factor ϕ_{bn} as follows:

CONCRETE TYPE	PERMISSIBLE INSTALLATION CONDITIONS	BOND STRENGTH	ASSOCIATED STRENGTH REDUCTION FACTOR
Uncracked	Dry	τ_{uncr}	ϕ_d
	Water-saturated	τ_{uncr}	ϕ_{ws}
Cracked	Dry	τ_{cr}	ϕ_d
	Water-saturated	τ_{cr}	ϕ_{ws}

Figure 1 of this report presents a bond strength design selection flowchart. Strength reduction factors for determination of the bond strength are given in Tables 7, 10, 13 and 16 of this report. See Table 1. Adjustments to the bond strength may also be taken for increased concrete compressive strength as noted in the footnotes to the corresponding tables noted above.

4.1.5 Static Steel Strength in Shear: The nominal static strength of a single anchor in shear as governed by the steel, V_{sa} , in accordance with ACI 318-14 17.5.1.2 or ACI 318-11 D.6.1.2, as applicable, and the strength reduction factor, ϕ , in accordance with ACI 318-14 17.3.3 or ACI 318-11 D.4.3, as applicable, are given in Tables 5, 8, 11 and 14 for the anchor element types included in this report. See Table 1.

4.1.6 Static Concrete Breakout Strength in Shear: The nominal static concrete breakout strength of a single anchor or group of anchors in shear, V_{cb} or V_{cbg} , must be calculated in accordance with ACI 318-14 17.5.2 or ACI 318-11 D.6.2, as applicable, based on information given in Tables 6, 9, 12 and 15 of this report. See Table 1. The basic concrete breakout strength of a single anchor in shear, V_b , must be calculated in accordance with ACI 318-14 17.5.2.2 or ACI 318-11 D.6.2.2, as applicable, using the values of d given in Tables 5, 8, 11 and 14 for the corresponding anchor steel in lieu of d_a (2015, 2012 and 2009 IBC) and d_o (2006 IBC). In addition, h_{ef} must be substituted for ℓ_e . In no case shall ℓ_e exceed $8d$. The value of f'_c shall be limited to a maximum of 8,000 psi (55 MPa) in accordance with ACI 318-14 17.2.7 or ACI 318-11 D.3.7, as applicable.

4.1.7 Static Concrete Pryout Strength in Shear: The nominal static pryout strength of a single anchor or group of anchors in shear, V_{cp} or V_{cpg} , shall be calculated in accordance with ACI 318-14 17.5.3 or ACI 318-11 D.6.3, as applicable.

4.1.8 Interaction of Tensile and Shear Forces: For designs that include combined tension and shear, the interaction of tension and shear must be calculated in accordance with ACI 318-14 17.6 or ACI 318-11 D.7, as applicable.

4.1.9 Minimum Member Thickness, h_{min} , Anchor Spacing, s_{min} , and Edge Distance, c_{min} : In lieu of ACI 318-14 17.7.1 and 17.7.3 or ACI 318-11 D.8.1 and D.8.3, as applicable, values of s_{min} and c_{min} described in this report (Tables 6, 9, 12 and 15) must be observed for anchor design and installation. The minimum member thickness, h_{min} , described in this report (Tables 6, 9, 12 and 15) must be observed for anchor design and installation. For adhesive anchors that will remain untorqued, ACI 318-14 17.7.4 or ACI 318-11 D.8.4, as applicable.

4.1.10 Critical Edge Distance c_{ac} and $\psi_{cp,Na}$: The modification factor $\psi_{cp,Na}$, must be determined in accordance with ACI 318-14 17.4.5.5 or ACI 318-11 D.5.5.5, as applicable, except as noted below:

For all cases where $c_{Na}/c_{ac} < 1.0$, $\psi_{cp,Na}$ determined from ACI 318-14 Eq. 17.4.5.5b or ACI 318-11 Eq. D-27, as applicable, need not be taken less than c_{Na}/c_{ac} . For all other cases, $\psi_{cp,Na}$ shall be taken as 1.0.

The critical edge distance, c_{ac} must be calculated according to Eq. 17.4.5.5c for ACI 318-14 or Eq. D-27a for ACI 318-11, in lieu of ACI 318-14 17.7.6 or ACI 318-11 D.8.6, as applicable.

$$c_{ac} = h_{ef} \left(\frac{\tau_{k,uncr}}{1160} \right)^{0.4} \cdot \left[3.1 - 0.7 \frac{h}{h_{ef}} \right]$$

(Eq. 17.4.5.5c for ACI 318-14 or Eq. D-27a for ACI 318-11)

where

$\left[\frac{h}{h_{ef}} \right]$ need not be taken as larger than 2.4; and

$\tau_{k,uncr}$ = the characteristic bond strength stated in the tables of this report whereby $\tau_{k,uncr}$ need not be taken as larger than:

$$\tau_{k,uncr} = \frac{k_{uncr} \sqrt{h_{eff} f'_c}}{\pi \cdot d_a} \tag{Eq. 4-1}$$

4.1.11 Design Strength in Seismic Design Categories C, D, E and F: In structures assigned to Seismic Design Category C, D, E or F under the IBC or IRC, anchors must be designed in accordance with ACI 318-14 17.2.3 or 318-11 D.3.3, as applicable, except as described below.

The nominal steel shear strength, V_{sa} , must be adjusted by $\alpha_{V,seis}$ as given in Tables 5, 8, 11 and 14 of this report for the anchor element types included in this report. The nominal bond strength τ_{cr} must be adjusted by $\alpha_{N,seis}$ as noted in Tables 7, 10, 13 and 16 of this report.

As an exception to ACI 318-11 D.3.3.4.2: Anchors designed to resist wall out-of-plane forces with design strengths equal to or greater than the force determined in accordance with ASCE 7 Equation 12.11-1 or 12.14-10 shall be deemed to satisfy Section ACI 318-11 D.3.3.4.3(d).

Under ACI 318-11 D.3.3.4.3(d), in lieu of requiring the anchor design tensile strength to satisfy the tensile strength requirements of ACI 318-11 D.4.1.1, the anchor design tensile strength shall be calculated from ACI 318-11 D.3.3.4.4.

The following exceptions apply to ACI 318-11 D.3.3.5.2:

1. For the calculation of the in-plane shear strength of anchor bolts attaching wood sill plates of bearing or non-bearing walls of light-frame wood structures to foundations or foundation stem walls, the in-plane shear strength in accordance with ACI 318-11 D.6.2 and D.6.3 need not be computed and ACI 318-11 D.3.3.5.3 need not apply provided all of the following are satisfied:

- 1.1. The allowable in-plane shear strength of the anchor is determined in accordance with AF&PA NDS Table 11E for lateral design values parallel to grain.
- 1.2. The maximum anchor nominal diameter is $5/8$ inch (16 mm).
- 1.3. Anchor bolts are embedded into concrete a minimum of 7 inches (178 mm).
- 1.4. Anchor bolts are located a minimum of $1 3/4$ inches (45 mm) from the edge of the concrete parallel to the length of the wood sill plate.

1.5. Anchor bolts are located a minimum of 15 anchor diameters from the edge of the concrete perpendicular to the length of the wood sill plate.

1.6. The sill plate is 2-inch or 3-inch nominal thickness.

2. For the calculation of the in-plane shear strength of anchor bolts attaching cold-formed steel track of bearing or non-bearing walls of light-frame construction to foundations or foundation stem walls, the in-plane shear strength in accordance with ACI 318-11 D.6.2 and D.6.3 need not be computed and ACI 318-11 D.3.3.5.3 need not apply provided all of the following are satisfied:

2.1. The maximum anchor nominal diameter is $\frac{5}{8}$ inch (16 mm).

2.2. Anchors are embedded into concrete a minimum of 7 inches (178 mm).

2.3. Anchors are located a minimum of $1\frac{3}{4}$ inches (45 mm) from the edge of the concrete parallel to the length of the track.

2.4. Anchors are located a minimum of 15 anchor diameters from the edge of the concrete perpendicular to the length of the track.

2.5. The track is 33 to 68 mil designation thickness.

Allowable in-plane shear strength of exempt anchors, parallel to the edge of concrete shall be permitted to be determined in accordance with AISI S100 Section E3.3.1.

3. In light-frame construction, bearing or nonbearing walls, shear strength of concrete anchors less than or equal to 1 inch [25 mm] in diameter attaching a sill plate or track to foundation or foundation stem wall need not satisfy ACI 318-11 D.3.3.5.3(a) through (c) when the design strength of the anchors is determined in accordance with ACI 318-11 D.6.2.1(c).

4.2 Installation:

Installation parameters are illustrated in Figure 2 of this report. Installation must be in accordance with ACI 318-14 17.8.1 and 17.8.2 or ACI 318-11 D.9.1 and D.9.2, as applicable. Adhesive anchor locations must comply with this report and the plans and specifications approved by the code official. Installation of the fischer FIS EM Adhesive Anchor System must conform to the manufacturer's printed installation instructions included in each unit package as described in Figure 5 of this report.

The adhesive anchor system may be used for upwardly inclined orientation applications (e.g. overhead). Upwardly inclined, horizontal, and drill depths deeper than 6 inches (150 mm) are to be installed using injection adaptors in accordance with the MPII as shown in Figure 5 of this report. The injection adaptor corresponding to the hole diameter must be attached to the extension tubing and static mixer supplied by fisher.

4.3 Special Inspection:

Periodic special inspection must be performed where required in accordance with Sections 1705.1.1 and Table 1705.3 of the 2015 and 2012 IBC, Table 1704.4 and Section 1704.15 of the 2009 IBC, or Section 1704.13 of the 2006 IBC and this report. The special inspector must be on the jobsite initially during anchor installation to verify anchor type, anchor dimensions, concrete type, concrete compressive strength, adhesive identification and expiration date, hole dimensions, hole cleaning procedures, anchor spacing, edge distances, concrete thickness, anchor embedment, tightening torque and adherence to the manufacturer's published installation instructions.

The special inspector must verify the initial installations of each type and size of adhesive anchor by construction personnel on site. Subsequent installations of the same anchor type and size by the same construction personnel are permitted to be performed in the absence of the special inspector. Any change in the anchor product being installed or the personnel performing the installation requires an initial inspection. For ongoing installations over an extended period, the special inspector must make regular inspections to confirm correct handling and installation of the product.

Continuous special inspection of adhesive anchors installed in horizontal or upwardly inclined orientations to resist sustained tension loads shall be performed in accordance with ACI 318-14 17.8.2.4, 26.7.1(h) and 26.13.3.2(c) or ACI 318-11 D.9.2.4, as applicable.

Under the IBC, additional requirements as set forth in Sections 1705, 1706, or 1707 must be observed, where applicable.

5.0 CONDITIONS OF USE

The fischer FIS EM Adhesive Anchor System described in this report is a suitable alternative to what is specified in the codes listed in Section 1.0 of this report, subject to the following conditions:

- 5.1 fischer FIS EM adhesive anchors must be installed in accordance with this report and the manufacturer's printed installation instructions included in the adhesive packaging and described in Figure 5 of this report.
- 5.2 The anchors must be installed in cracked or uncracked normal-weight concrete having a specified compressive strength $f'_c = 2,500$ psi to 8,500 psi (17.2 MPa to 58.6 MPa).
- 5.3 The values of f'_c used for calculation purposes must not exceed 8,000 psi (55 MPa).
- 5.4 Anchors must be installed in concrete base materials in holes predrilled in accordance with the instructions provided in Figure 5 of this report.
- 5.5 Loads applied to the anchors must be adjusted in accordance with Section 1605.2 of the IBC for strength design.
- 5.6 fischer FIS EM adhesive anchors are recognized for use to resist short- and long-term loads, including wind and earthquake loads, subject to the conditions of this report.
- 5.7 In structures assigned to Seismic Design Category C, D, E or F under the IBC or IRC, anchor strength must be adjusted in accordance with Section 4.1.11 of this report.
- 5.8 fischer FIS EM adhesive anchors are permitted to be installed in concrete that is cracked or that may be expected to crack during the service life of the anchor, subject to the conditions of this report.
- 5.9 Strength design values are established in accordance with Section 4.1 of this report.
- 5.10 Minimum anchor spacing and edge distance, as well as minimum member thickness, must comply with the values given in this report.
- 5.11 Prior to installation, calculations and details demonstrating compliance with this report must be submitted to the code official. The calculations and details must be prepared by a registered design professional where required by the statutes of the jurisdiction in which the project is to be constructed.

- 5.12** The fischer FIS EM Adhesive Anchoring System is not permitted to support fire-resistive construction. Where not otherwise prohibited by the code, the fischer FIS EM Adhesive Anchoring System is permitted for installation in fire-resistive construction provided that at least one of the following conditions is fulfilled:
- Anchors are used to resist wind or seismic forces only.
 - Anchors that support gravity load-bearing structural elements are within a fire-resistive envelope or a fire-resistive membrane, are protected by approved fire-resistive materials, or have been evaluated for resistance to fire exposure in accordance with recognized standards.
 - Anchors are used to support nonstructural elements.
- 5.13** Since an ICC-ES acceptance criteria for evaluating data to determine the performance of adhesive anchors subjected to fatigue or shock loading is unavailable at this time, the use of these anchors under such conditions is beyond the scope of this report.
- 5.14** Use of zinc-plated carbon steel threaded rods or steel reinforcing bars is limited to dry, interior locations.
- 5.15** Use of hot-dipped galvanized carbon steel and stainless steel rods is permitted for exterior exposure or damp environments.
- 5.16** Steel anchoring materials in contact with preservative-treated and fire-retardant-treated wood must be of zinc-coated carbon steel or stainless steel. The minimum coating weights for zinc-coated steel must comply with ASTM A153.

- 5.17** Periodic special inspection must be provided in accordance with Section 4.3 of this report. Continuous special inspection for anchors installed in horizontal or upwardly inclined orientations resist sustained tension loads must be provided in accordance with Section 4.3 of this report.
- 5.18** Installation of anchors in horizontal or upwardly inclined orientations to resist sustained tension loads shall be performed by personnel certified by an applicable certification program in accordance with ACI 318-14 17.8.2.2 or 17.8.2.3 or ACI 318-11 D.9.2.2 or D.9.2.3, as applicable.
- 5.19** fischer FIS EM adhesive is manufactured by fischerwerke GmbH & Co. KG, Denzlingen, Germany, under a quality-control program with inspections by ICC-ES.

6.0 EVIDENCE SUBMITTED

Data in accordance with the ICC-ES Acceptance Criteria for Post-Installed Adhesive Anchors in Concrete Elements (AC308), dated October 2016.

7.0 IDENTIFICATION

- 7.1** fischer FIS EM adhesive is identified by packaging labeled with the manufacturer’s name (fischerwerke) and address, product name, lot number, expiration date, and the evaluation report number (ESR-1990).
- 7.2** Threaded rods, nuts, washers and deformed reinforcing bars are standard elements and must conform to applicable national or international specifications as set forth in Tables 2, 3, and 4 of this report.

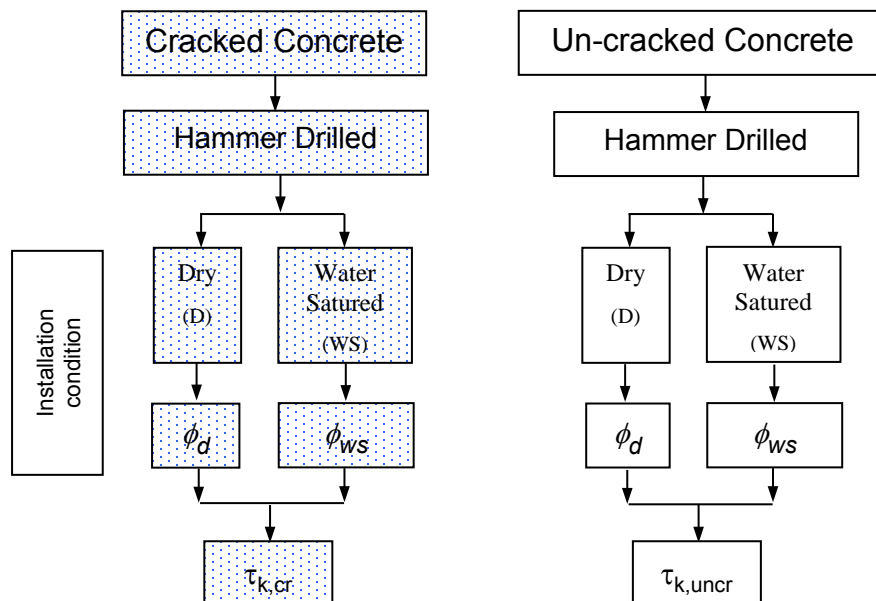

FIGURE 1—FLOWCHART STRENGTH REDUCTION FACTORS FOR DETERMINATION OF THE BOND STRENGTH

TABLE 1—DESIGN TABLE INDEX

Design strength ¹		Threaded rod		Deformed reinforcement	
		Metric	Fractional	Metric	Fractional
Steel	N_{sa}, V_{sa}	Table 5	Table 11	Table 8	Table 14
Concrete	$N_{cb}, N_{cbg}, V_{cb}, V_{cbg}, V_{cp}, V_{cpb}$	Table 6	Table 12	Table 9	Table 15
Bond ²	N_b, N_{bg}	Table 7	Table 13	Table 10	Table 16
Bond reduction factors	ϕ_d, ϕ_{ws}	Table 7	Table 13	Table 10	Table 16

¹Design strengths are as set forth in ACI 318-14 17.3.1.1 or ACI 318-11 D.4.1.1, as applicable.

²See Section 4.1 of this report for bond strength information.

TABLE 2—SPECIFICATIONS AND PHYSICAL PROPERTIES OF COMMON CARBON STEEL THREADED ROD MATERIALS AND fischer THREADED RODS FIS A AND RG M¹

THREADED ROD SPECIFICATION		Minimum specified ultimate strength (f_{uta})	Minimum specified yield strength 0.2% offset (f_{ya})	f_{uta}/f_{ya}	Elongation, min. (percent) ⁷	Reduction of Area, min. (percent)	Specification for nuts ⁸
							
ASTM F568M ³ Class 5.8 (equivalent to ISO 898-1 ² Class 5.8)	MPa (psi)	500 (72,519)	400 (58,015)	1.25	10	35	DIN 934 Grade 6 (8-A2K) (Metric) ASTM A563 Grade DH
ISO 898-1 ² Class 8.8	MPa (psi)	800 (116,030)	640 (92,824)	1.25	12	52	DIN 934 Grade 8 (8-A2K)
ASTM A36 ⁴ and F1554 ⁵ Grade 36	MPa (psi)	400 (58,000)	248 (36,000)	1.61	23	40	ASTM A194 / A563 Grade A
ASTM F1554 ⁵ Grade 55	MPa (psi)	517 (75,000)	380 (55,000)	1.36	23	40	
ASTM A193 ⁶ Grade B7 $\leq 2\frac{1}{2}$ in. (≤ 64 mm)	MPa (psi)	862 (125,000)	724 (105,000)	1.19	16	50	ASTM A194 / A563 Grade DH
ASTM F1554 ⁵ Grade 105	MPa (psi)	862 (125,000)	724 (105,000)	1.19	15	45	

¹fischer FIS EM must be used with continuously threaded carbon steel rod (all-thread) that have thread characteristics comparable with ANSI B1.1 UNC Coarse Thread Series or ANSI B1.13M M Profile Metric Thread Series.

²Mechanical properties of fasteners made of carbon steel and alloy steel – Part 1: Bolts, screws and studs.

³Standard Specification for Carbon and Alloy Steel Externally Threaded Metric Fasteners.

⁴Standard Specification for Carbon Structural Steel.

⁵Standard Specification for Anchor Bolts, Steel, 36, 55 and 105ksi Yield Strength.

⁶Standard Specification for Alloy Steel and Stainless Steel Bolting Materials for High Temperature Service.

⁷Based on 2-in. (50 mm) gauge length except ISO 898, which is based on 5d.

⁸Nuts of other grades and styles having specified proof load stresses greater than the specified grade and style are also suitable. Nuts must have specified proof load stresses equal or greater than the minimum tensile strength of the specific threaded rods.

TABLE 3—SPECIFICATIONS AND PHYSICAL PROPERTIES OF COMMON STAINLESS STEEL THREADED ROD MATERIALS AND fischer THREADED RODS FIS A AND RG M¹

THREADED ROD SPECIFICATION			Minimum specified ultimate strength (f_{uta})	Minimum specified yield strength 0.2% offset (f_{ya})	f_{uta}/f_{ya}	Elongation, min. (percent)	Reduction of Area, min. (percent)	Specification for nuts ⁶
	ISO 3056-1 ² A4-80 M8-M30	MPa	800	600	1.34	12	-	ISO 4032
		(psi)	(116,000)	(87,000)				
ISO 3506-1 ² A4-70 M8-M30	MPa	700	450	1.56	16	-	ISO 4032	
	(psi)	(101,500)	(65,250)					
ISO 3506-1 ² stainless C-80 M8-M30	MPa	800	600	1.34	12	-	ISO 4032	
	(psi)	(116,000)	(87,000)					
ISO 3506-1 ² stainless C-70 M8-M30	MPa	700	450	1.56	16	-	ISO 4032	
	(psi)	(101,500)	(65,250)					
ASTM F593 ³ CW1 (316) ¹ / ₄ to ⁵ / ₈ in.	MPa	689	448	1.54	20	-	ASTM F594 Alloy group 1, 2, 3	
	(psi)	(100,000)	(65,000)					
ASTM F593 ³ CW2 (316) ³ / ₄ to 1 ¹ / ₂ in.	MPa	586	310	1.89	25	-		
	(psi)	(85,000)	(45,000)					
ASTM A193 ⁴ Grad B8/B8M, Class 1	MPa	517	207	2.50	30	50		
	(psi)	(75,000)	(30,000)					
ASTM A193 ⁴ Grad B8/B8M, Class 2B	MPa	655	517	1.27	25	40		
	(psi)	(95,000)	(75,000)					

¹fischer FIS EM may be used with continuously threaded stainless steel rod (all-thread) with thread characteristics comparable with ANSI B1.1 UNC Coarse Thread Series or ANSI B1.13M M Profile Metric Thread Series.

²Mechanical properties of corrosion resistant stainless steel fasteners – Part 1: Bolts, screws and studs

³Standard Steel Specification for Stainless Steel Bolts, Hex Cap Screws and Studs.

⁴Standard Specification for Alloy Steel and Stainless Steel Bolting Materials for High Temperature Service.

⁵Based on 2-in. (50 mm) gauge length except ISO 898, which is based on 5d.

⁶Nuts of other grades and styles having specified proof load stresses greater than the specified grade and style are also suitable. Nuts must have specified proof load stresses equal or greater than the minimum tensile strength of the specific threaded rods. Material types of the nuts and washers must be matched to the threaded rods.

TABLE 4—SPECIFICATIONS AND PHYSICAL PROPERTIES OF COMMON STEEL REINFORCING BARS

REINFORCING BAR SPECIFICATION		Minimum specified ultimate strength (f_{uta})	Minimum specified yield strength (f_{ya})
DIN 488 BSt 500 ¹	MPa	550	500
	(psi)	(79,750)	(72,500)
ASTM A615 ² , ASTM A767 ³ Gr. 40	MPa	414	276
	(psi)	(60,000)	(40,000)
ASTM A615 ² , ASTM A767 ³ Gr. 60	MPa	620	420
	(psi)	(90,000)	(60,000)
ASTM A706 ⁴ , ASTM A767 ³ Gr. 60	MPa	550	414
	(psi)	(80,000)	(60,000)

¹Reinforcing steel; reinforcing steel bars; dimensions and masses.

²Standard Specification for Deformed and Plain Carbon Steel Bars for Concrete Reinforcement.

³Standard Specification for Zinc-Coated (Galvanized) Steel Bars for Concrete Reinforcement.

⁴Billet Steel Bars for Concrete Reinforcement.

TABLE 5—STEEL DESIGN INFORMATION FOR METRIC THREADED ROD¹

DESIGN INFORMATION		SYMBOL	UNITS	NOMINAL ROD DIAMETER (mm)					
				M10	M12	M16	M20	M24	M30
Rod Outside Diameter		<i>d</i>	mm	10	12	16	20	24	30
			(in.)	(0.39)	(0.47)	(0.63)	(0.79)	(0.94)	(1.18)
ROD effective cross-sectional area		<i>A_{se}</i>	mm ²	58.0	84.3	156.7	244.8	352.5	560.7
			(in. ²)	(0.090)	(0.131)	(0.243)	(0.379)	(0.546)	(0.869)
ISO 898-1 Class 5.8	Nominal strength as governed by steel strength	<i>N_{sa}</i>	kN	29.0	42.2	78.4	122.4	176.3	280.4
			(lb)	(6,522)	(9,476)	(17,615)	(27,519)	(39,625)	(63,033)
		<i>V_{sa}</i>	kN	17.4	25.3	47.0	73.4	105.8	168.2
			(lb)	(3,912)	(5,686)	(10,569)	(16,511)	(23,775)	(37,820)
	Reduction for seismic shear	$\alpha_{V,seis}$	-	1.0				0.87	
	Strength reduction factor ϕ for tension ²	ϕ	-	0.65					
Strength reduction factor ϕ for shear ²	ϕ	-	0.60						
ISO 898-1 Class 8.8	Nominal strength as governed by steel strength	<i>N_{sa}</i>	kN	46.4	67.4	125.3	195.8	282.0	448.5
			(lb)	(10,435)	(15,151)	(28,167)	(44,015)	(63,393)	(100,822)
		<i>V_{sa}</i>	kN	27.8	40.5	75.2	117.5	169.2	269.1
			(lb)	(6,250)	(9,104)	(16,904)	(26,414)	(38,103)	(60,493)
	Reduction for seismic shear	$\alpha_{V,seis}$	-	0.90					
	Strength reduction factor ϕ for tension ²	ϕ	-	0.65					
Strength reduction factor ϕ for shear ²	ϕ	-	0.60						
ISO 3506-1 Class A4-70 and stainless C-70	Nominal strength as governed by steel strength	<i>N_{sa}</i>	kN	40.6	59.0	109.7	171.4	246.8	392.5
			(lb)	(9,128)	(13,267)	(24,661)	(38,525)	(55,474)	(88,240)
		<i>V_{sa}</i>	kN	24.4	35.4	65.8	102.8	148.1	235.5
			(lb)	(5,477)	(7,960)	(14,796)	(23,115)	(33,285)	(52,944)
	Reduction for seismic shear	$\alpha_{V,seis}$	-	0.90					
	Strength reduction factor ϕ for tension ²	ϕ	-	0.65					
Strength reduction factor ϕ for shear ²	ϕ	-	0.60						
ISO 3506-1 Class A4-80 and stainless C-80	Nominal strength as governed by steel strength	<i>N_{sa}</i>	kN	46.4	67.4	125.4	195.8	282.0	448.6
			(lb)	(10,432)	(15,162)	(28,183)	(44,029)	(63,399)	(100,845)
		<i>V_{sa}</i>	kN	27.8	40.5	75.2	117.5	169.2	269.1
			(lb)	(6,259)	(9,097)	(16,910)	(26,417)	(38,040)	(60,507)
	Reduction for seismic shear	$\alpha_{V,seis}$	-	0.90					
	Strength reduction factor ϕ for tension ²	ϕ	-	0.65					
Strength reduction factor ϕ for shear ²	ϕ	-	0.60						

For SI: 1 inch = 25.4 mm, 1lbf = 4.448 N, 1 psi = 0.006897 MPa.
 For pound-inch units: 1 mm = 0.03937 inch, 1 N = 0.2248 lbf, 1MPa = 145.0 psi.

¹Values provided for common rod material types are based on specified strength and calculated in accordance with ACI 318-14 Eq. 17.4.1.2 and Eq. 17.5.1.2b or ACI 318-11 Eq. D-2 and Eq. D-29, as applicable. Nuts and washers must be appropriate for the rod strength and type.

²For use with load combinations, Section 1605.2 of the IBC, ACI 318-14 5.3 or ACI 318-11 9.2, as applicable, as set forth in ACI 318-14 17.3.3 or ACI 318-11 D.4.3, as applicable. If the load combinations of ACI 318-11 Appendix C are used, the appropriate value of ϕ must be determined in accordance with ACI 318-11 D.4.4. Values correspond to a brittle steel element.

TABLE 6—CONCRETE BREAKOUT DESIGN INFORMATION FOR METRIC THREADED ROD

DESIGN INFORMATION	SYMBOL	UNITS	NOMINAL ROD DIAMETER (mm)					
			10	12	16	20	24	30
Min. embedment depth	$h_{ef,min}$	mm	60	70	80	90	96	120
		(in.)	(2.36)	(2.76)	(3.15)	(3.54)	(3.78)	(4.72)
Max. embedment depth	$h_{ef,max}$	mm	200	240	320	400	480	600
		(in.)	(7.87)	(9.45)	(12.60)	(15.75)	(18.90)	(23.62)
Effectiveness factor for cracked concrete	$k_{c,cr}$	SI	7.1					
		(in.lb)	(17)					
Effectiveness factor for uncracked concrete	$k_{c,uncr}$	SI	10					
		(in.lb)	(24)					
Min. anchor spacing	s_{min}	mm / (in.)	$s_{min} = c_{min}$					
Min. edge distance	c_{min}	mm	45	55	65	85	105	140
		(in.)	(1.77)	(2.17)	(2.56)	(3.35)	(4.13)	(5.51)
Minimum member thickness	h_{min}	mm	$h_{ef} + 30 (\geq 100)$		$h_{ef} + 2d_0^2$			
		(in.)	$h_{ef} + 1.25 (\geq 3.937)$					
Critical edge distance for splitting failure	c_{ac}	mm (in.)	See Section 4.1.10 of this report.					
Strength reduction factor for tension, concrete failure modes, Condition B ¹	ϕ	-	0.65					
Strength reduction factor for shear, concrete failure modes, Condition B ¹	ϕ	-	0.70					

For SI: 1 inch = 25.4 mm, 1lbf = 4.448 N, 1 psi = 0.006897 MPa.
 For pound-inch units: 1 mm = 0.03937 inch, 1 N = 0.2248 lbf, 1MPa = 145.0 psi.

¹Values provided for post-installed anchors with category as determined from ACI 355.4 given for Condition B. Condition B applies without supplementary reinforcement or where pullout (bond) or pryout govern, as set forth in ACI 318-14 17.3.3 or ACI 318-11 D.4.3, as applicable, while condition A requires supplemental reinforcement. Values are for use with load combinations Section 1605.2 of the IBC, ACI 318-14 5.3 or ACI 318-11 9.2, as applicable, as set forth in ACI 318-14 17.3.3 or ACI 318-11 D.4.3, as applicable. If the load combinations of ACI 318-11 Appendix C are used, the appropriate value of ϕ must be determined in accordance with ACI 318-11 D.4.4.

² d_0 = drill hole diameter

TABLE 7—BOND STRENGTH DESIGN INFORMATION FOR METRIC THREADED ROD¹

DESIGN INFORMATION		SYMBOL	UNITS	Nominal rod diameter (mm)					
				10	12	16	20	24	30
Min. embedment depth		$h_{ef,min}$	mm	60	70	80	90	96	120
			(in.)	(2.36)	(2.76)	(3.15)	(3.54)	(3.78)	(4.72)
Max. embedment depth		$h_{ef,max}$	mm	200	240	320	400	480	600
			(in.)	(7.87)	(9.45)	(12.60)	(15.75)	(18.90)	(23.62)
Temperature range A ³	Characteristic bond strength in cracked concrete ²	$\tau_{k,cr}$	N/mm ²	6.3	5.8	5.7	5.2	5.0	4.9
			(psi)	(915)	(840)	(830)	(755)	(725)	(710)
	Characteristic bond strength in uncracked concrete ²	$\tau_{k,uncr}$	N/mm ²	12.0	11.5	10.7	10.1	9.7	9.2
			(psi)	(1740)	(1670)	(1550)	(1465)	(1405)	(1335)
Reduction for seismic tension		$\alpha_{N,seis}$	-	0.95			1.0		
Strength reduction factor for permissible installation conditions	Dry concrete	ϕ_d	-	0.65					
	Water saturated concrete	ϕ_{ws}	-	0.65					

For SI: 1 inch = 25.4 mm, 1lbf = 4.448 N, 1 psi = 0.006897 MPa.

For pound-inch units: 1 mm = 0.03937 inch, 1 N = 0.2248 lbf, 1MPa = 145.0 psi.

¹Characteristic bond strength values correspond to concrete compressive strength in the range 2,500 psi ≤ f'_c ≤ 4,500 psi. For the range 4,500 psi < f'_c ≤ 6,500 psi may be increased by 6% and range 6,500 psi < f'_c ≤ 8,000 psi tabulated characteristic bond strength may be increased by 10%.

²Characteristic bond strengths are for sustained loads including dead and live loads. For short-term loads including wind, bond strength may be increased 39 percent for temperature range A.

³Temperature range A: Maximum short term temperature = 162°F (72°C), Maximum long term Temperature = 122°F (50°C).

Short term elevated concrete temperatures are those that occur over brief intervals, e.g., as a results of diurnal cycling. Long term concrete temperatures are roughly constant over significant periods of time.

TABLE 8—STEEL DESIGN INFORMATION FOR METRIC COMMON STEEL REINFORCING BARS¹

DESIGN INFORMATION		Symbol	Units	Bar size						
				10	12	16	20	25	28	32
Nominal bar diameter		d	mm	10	12	16	20	25	28	32
			(in.)	(0.39)	(0.47)	(0.63)	(0.79)	(0.98)	(1.10)	(1.26)
Bar effective cross-sectional area		A_{se}	mm ²	78.5	113.1	201.1	314.2	490.9	615.8	804.2
			(in. ²)	(0.112)	(0.175)	(0.312)	(0.487)	(0.761)	(0.954)	(1.247)
DIN 488 BSt 550/500	Nominal strength as governed by steel strength	N_{sa}	kN	43.2	62.2	110.6	172.8	270.0	338.7	443.2
			(lb)	(9,712)	(13,985)	(24,862)	(38,848)	(60,701)	(76,138)	(99,437)
		V_{sa}	kN	25.9	37.3	66.4	103.7	162.0	203.2	265.4
			(lb)	(5,827)	(8,391)	(14,917)	(23,314)	(36,420)	(45,683)	(59,667)
	Reduction for seismic shear		$\alpha_{V,seis}$	-	1.0					
	Strength reduction factor ϕ for tension ²		ϕ	-	0.65					
Strength reduction factor ϕ for shear ²		ϕ	-	0.60						

For SI: 1 inch = 25.4 mm, 1lbf = 4.448 N, 1 psi = 0.006897 MPa.

For pound-inch units: 1 mm = 0.03937 inch, 1 N = 0.2248 lbf, 1MPa = 150.0 psi.

¹Values provided for common reinforcing bar based on specified strength and calculated in accordance with ACI 318-14 Eq. 17.4.1.2 and Eq. 17.5.1.2b or ACI 318-11 Eq. D-2 and Eq. D-29, as applicable. Nuts and washers must be appropriated for the rod strength and type.

²For use with load combinations Section 1605.2 of the IBC, ACI 318-14 5.3 or ACI 318-11 9.2, as applicable, as set forth in ACI 318-14 17.3.3 or ACI 318-11 D.4.3, as applicable. If the load combinations of ACI 318-11 Appendix C are used, the appropriate value of ϕ must be determined in accordance with ACI 318-11 D.4.4. Values correspond to a brittle steel element.

TABLE 9—CONCRETE BREAKOUT STRENGTH DESIGN INFORMATION FOR COMMON STEEL REINFORCING BARS¹

DESIGN INFORMATION	Symbol	Units	Bar size						
			10	12	16	20	25	28	32
Min. embedment depth	$h_{ef,min}$	mm	60	70	80	90	100	112	128
		(in.)	(2.36)	(2.76)	(3.15)	(3.54)	(3.94)	(4.41)	(5.04)
Max. embedment depth	$h_{ef,max}$	mm	200	240	320	400	500	560	640
		(in.)	(7.87)	(9.45)	(12.60)	(15.75)	(19.69)	(22.05)	(25.20)
Effectiveness factor for cracked concrete	$k_{c,cr}$	SI	7.1						
		(in.lb)	(17)						
Effectiveness factor for uncracked concrete	$k_{c,uncr}$	SI	10						
		(in.lb)	(24)						
Min. anchor spacing	s_{min}	mm / (in.)	$s_{min} = c_{min}$						
Min. edge distance	c_{min}	mm	45	55	65	85	110	130	160
		(in.)	(1.77)	(2.17)	(2.56)	(3.35)	(4.33)	(5.12)	(6.30)
Minimum member thickness	h_{min}	mm	$h_{ef} + 30 (\geq 100)$		$h_{ef} + 2d_0^{2)}$				
		(in.)	$h_{ef} + 1.25 (\geq 3.937)$						
Critical edge distance for splitting failure	c_{ac}	mm (in.)	See Section 4.1.10 of this report.						
Strength reduction factor for tension, concrete failure modes, Condition B ¹	ϕ	-	0.65						
Strength reduction factor for shear, concrete failure modes, Condition B ¹	ϕ	-	0.70						

For SI: 1 inch = 25.4 mm, 1lbf = 4.448 N, 1 psi = 0.006897 MPa.

For pound-inch units: 1 mm = 0.03937 inch, 1 N = 0.2248 lbf, 1MPa = 145.0 psi.

¹Values provided for post-installed anchors with category as determined from ACI 355.4 given for Condition B. Condition B applies without supplementary reinforcement or where pullout (bond) or pryout govern, as set forth in ACI 318-14 17.3.3 or ACI 318-11 D.4.3, as applicable, while condition A requires supplemental reinforcement. Values are for use with load combinations Section 1605.2 of the IBC, ACI 318-14 5.3 or ACI 318-11 9.2, as applicable, as set forth in ACI 318-14 17.3.3 or ACI 318-11 D.4.3, as applicable. If the load combinations of ACI 318-11 Appendix C are used, the appropriate value of ϕ must be determined in accordance with ACI 318-11 D.4.4.

² d_0 = drill hole diameter

TABLE 10—BOND STRENGTH DESIGN INFORMATION FOR COMMON STEEL REINFORCING BARS¹

DESIGN INFORMATION		Symbol	Units	Bar size						
				10	12	16	20	25	28	32
Min. embedment depth		$h_{ef,min}$	mm	60	70	80	90	100	112	128
			(in.)	(2.36)	(2.76)	(3.15)	(3.54)	(3.94)	(4.41)	(5.04)
Max. embedment depth		$h_{ef,max}$	mm	200	240	320	400	500	560	640
			(in.)	(7.87)	(9.45)	(12.60)	(15.75)	(19.69)	(22.05)	(25.20)
Temperature range A ³	Characteristic bond strength in cracked concrete ²	$\tau_{k,cr}$	N/mm ²	5.5			5.7			
			(psi)	(795)			(825)			
	Characteristic bond strength in uncracked concrete ²	$\tau_{k,uncr}$	N/mm ²	9.3						
			(psi)	(1,350)						
Reduction for seismic tension		$\alpha_{N,seis}$	-	0.95					1.0	
Strength reduction factor for permissible installation conditions	Dry concrete	ϕ_d	-	0.65						
	Water saturated concrete	ϕ_{ws}	-	0.65						

For SI: 1 inch = 25.4 mm, 1 lbf = 4.448 N, 1 psi = 0.006897 MPa.
 For pound-inch units: 1 mm = 0.03937 inch, 1 N = 0.2248 lbf, 1 MPa = 145.0 psi.

¹Characteristic bond strength values correspond to concrete compressive strength in the range 2,500 psi ≤ f_c ≤ 4,500 psi. For the range 4,500 psi < f_c ≤ 6,500 psi may be increased by 6% and range 6,500 psi < f_c ≤ 8,000 psi tabulated characteristic bond strength may be increased by 10%.

²Characteristic bond strengths are for sustained loads including dead and live loads. For short-term loads including wind, bond strength may be increased 39 percent for temperature range A.

³Temperature range A: Maximum short term temperature = 162°F (72°C), Maximum long term Temperature = 122°F (50°C)
 Short term elevated concrete temperatures are those that occur over brief intervals, e.g., as a result of diurnal cycling. Long term concrete temperatures are roughly constant over significant periods of time.

TABLE 11—STEEL DESIGN INFORMATION FOR FRACTIONAL THREADED ROD¹

DESIGN INFORMATION		Symbol	Units	Nominal rod diameter (in.)						
				³ / ₈ "	¹ / ₂ "	⁵ / ₈ "	³ / ₄ "	⁷ / ₈ "	1"	1 ¹ / ₄ "
Rod Outside Diameter		<i>d</i>	in.	³ / ₈	¹ / ₂	⁵ / ₈	³ / ₄	⁷ / ₈	1	1 ¹ / ₄
			(mm)	(9.5)	(12.7)	(15.9)	(19.1)	(22.2)	(25.4)	(31.8)
Rod effective cross-sectional area		<i>A_{se}</i>	in ²	0.0775	0.1419	0.2260	0.3345	0.4617	0.6057	0.9691
			(mm ²)	(50)	(92)	(146)	(216)	(298)	(391)	(625)
ASTM F568M Class 5.8 / ISO 898-1 Class 5.8	Nominal strength as governed by steel strength	<i>N_{sa}</i>	lb	5,621	10,286	16,389	24,258	33,487	43,930	70,279
			(kN)	(25.0)	(45.8)	(72.9)	(107.9)	(149.0)	(195.4)	(312.6)
		<i>V_{sa}</i>	lb	3,372	6,171	9,834	14,555	20,092	26,358	42,167
			(kN)	(15.0)	(27.5)	(43.7)	(64.7)	(89.4)	(117.2)	(187.6)
	Reduction for seismic shear	<i>α_{V,seis}</i>	-	0.74				0.60		
	Strength reduction factor <i>φ</i> for tension ²	<i>φ</i>	-	0.65						
Strength reduction factor <i>φ</i> for shear ²	<i>φ</i>	-	0.60							
ASTM A36 Grade 36 / F1554 Grade 36	Nominal strength as governed by steel strength	<i>N_{sa}</i>	lb	4,496	8,228	13,112	19,406	26,790	35,144	56,223
			(kN)	(20.0)	(36.8)	(58.3)	(86.3)	(119.2)	(156.3)	(250.1)
		<i>V_{sa}</i>	lb	2,698	4,964	7,877	11,654	16,078	21,095	33,720
			(kN)	(12.0)	(22.1)	(35.0)	(51.8)	(71.5)	(93.8)	(150.0)
	Reduction for seismic shear	<i>α_{V,seis}</i>	-	0.74				0.60		
	Strength reduction factor <i>φ</i> for tension ²	<i>φ</i>	-	0.75						
Strength reduction factor <i>φ</i> for shear ²	<i>φ</i>	-	0.65							
F1554 Grade 55	Nominal strength as governed by steel strength	<i>N_{sa}</i>	lb	5,812	10,635	16,947	25,083	34,626	45,423	72,668
			(kN)	(25.9)	(47.3)	(75.4)	(111.6)	(154.0)	(202.0)	(323.2)
		<i>V_{sa}</i>	lb	3,487	6,318	10,168	15,050	20,775	27,254	43,601
			(kN)	(15.5)	(28.4)	(45.2)	(66.9)	(92.4)	(121.2)	(193.9)
	Reduction for seismic shear	<i>α_{V,seis}</i>	-	0.74				0.60		
	Strength reduction factor <i>φ</i> for tension ²	<i>φ</i>	-	0.75						
Strength reduction factor <i>φ</i> for shear ²	<i>φ</i>	-	0.65							
ASTM A193 B7 ASTM F1554 Grade 105	Nominal strength as governed by steel strength	<i>N_{sa}</i>	lb	9,667	17,691	28,190	41,724	57,598	75,559	120,879
			(kN)	(43.0)	(78.7)	(125.4)	(185.6)	(256.2)	(336.1)	(537.7)
		<i>V_{sa}</i>	lb	5,800	10,615	16,914	25,034	34,559	45,336	72,528
			(kN)	(25.8)	(47.2)	(75.2)	(111.4)	(153.7)	(201.7)	(322.6)
	Reduction for seismic shear	<i>α_{V,seis}</i>	-	0.74				0.60		
	Strength reduction factor <i>φ</i> for tension ³	<i>φ</i>	-	0.75						
Strength reduction factor <i>φ</i> for shear ³	<i>φ</i>	-	0.65							

TABLE 11—STEEL DESIGN INFORMATION FOR FRACTIONAL THREADED ROD¹ (Continued)

DESIGN INFORMATION		Symbol	Units	Nominal rod diameter (in.)						
				³ / ₈ "	¹ / ₂ "	⁵ / ₈ "	³ / ₄ "	⁷ / ₈ "	1"	1 ¹ / ₄ "
ASTM A193 Grade B8/B8M Class 2B Stainless	Nominal strength as governed by steel strength	N_{sa}	lb	7,362	13,546	21,498	31,805	43,879	57,572	92,028
			(kN)	(32.8)	(60.3)	(95.6)	(141.5)	(195.2)	(256.1)	(409.4)
		V_{sa}	lb	4,418	8,084	12,882	19,067	26,321	34,529	55,239
			(kN)	(19.7)	(36.0)	(57.3)	(84.8)	(117.1)	(153.6)	(245.7)
	Reduction for seismic shear	$\alpha_{V,seis}$		0.74				0.60		
	Strength reduction factor ϕ for tension ²	ϕ		0.75						
Strength reduction factor ϕ for shear ³	ϕ		0.65							
ASTM F593, CW Stainless	Nominal strength as governed by steel strength	N_{sa}	lb	7,740	14,175	22,580	28,420	39,230	51,470	82,350
			(kN)	(34.4)	(63.1)	(100.4)	(126.4)	(174.5)	(228.9)	(366.3)
		V_{sa}	lb	4,654	8,516	13,570	17,058	23,548	30,891	49,420
			(kN)	(20.7)	(37.9)	(60.4)	(75.9)	(104.7)	(137.4)	(219.8)
	Reduction for seismic shear	$\alpha_{V,seis}$		0.74				0.60		
	Strength reduction factor ϕ for tension ²	ϕ		0.65						
Strength reduction factor ϕ for shear ³	ϕ	-	0.60							

For **SI**: 1 inch = 25.4 mm, 1 lbf = 4.448 N, 1 psi = 0.006897 MPa.
 For pound-inch units: 1 mm = 0.03937 inch, 1 N = 0.2248 lbf, 1 MPa = 145.0 psi.

¹Values provided for common rod material types are based on specified strength and calculated in accordance with ACI 318-14 Eq. 17.4.1.2 and Eq. 17.5.1.2b or ACI 318-11 Eq. D-2 and Eq. D-29, as applicable. Nuts and washers must be appropriate for the rod strength and type.

²For use with load combinations Section 1605.2 of the IBC, ACI 318-14 5.3 or ACI 318-11 9.2, as applicable, as set forth in ACI 318-14 17.3.3 or ACI 318-11 D.4.3, as applicable. If the load combinations of ACI 318-11 Appendix C are used, the appropriate value of ϕ must be determined in accordance with ACI 318-11 D.4.4. Values correspond to a brittle steel element.

³For use with load combinations Section 1605.2 of the IBC, ACI 318-14 5.3 or ACI 318-11 9.2, as applicable, as set forth in ACI 318-14 17.3.3 or ACI 318-11 D.4.3, as applicable. If the load combinations of ACI 318-11 Appendix C are used, the appropriate value of ϕ must be determined in accordance with ACI 318-11 D.4.4. Values correspond to a ductile steel element.

TABLE 12—CONCRETE BREAKOUT DESIGN INFORMATION FOR FRACTIONAL THREADED ROD¹

DESIGN INFORMATION	Symbol	Units	Nominal rod diameter (in.)						
			³ / ₈ "	¹ / ₂ "	⁵ / ₈ "	³ / ₄ "	⁷ / ₈ "	1"	1 ¹ / ₄ "
Min. embedment depth	$h_{ef,min}$	in.	2 ³ / ₈	2 ³ / ₄	3 ¹ / ₈	3 ¹ / ₂	3 ¹ / ₂	4	5
		(mm)	(60)	(70)	(79)	(89)	(89)	(102)	(127)
Max. embedment depth	$h_{ef,max}$	in.	7 ¹ / ₂	10	12 ¹ / ₂	15	17 ¹ / ₂	20	25
		(mm)	(191)	(254)	(318)	(381)	(445)	(508)	(635)
Effectiveness factor for cracked concrete	$k_{c,cr}$	in.lb	17						
		(SI)	7.1						
Effectiveness factor for uncracked concrete	$k_{c,uncr}$	in.lb	24						
		(SI)	10						
Min. anchor spacing	s_{min}	in. (mm)	$s_{min} = c_{min}$						
Min. edge distance	c_{min}	in.	1.69	2.28	2.56	3.15	3.74	4.33	6.30
		(mm)	(43)	(58)	(65)	(80)	(95)	(110)	(160)
Minimum member thickness	h_{min}	in.	$h_{ef} + 30 (\geq 100)$		$h_{ef} + 2d_o^{2)}$				
		(mm)	$h_{ef} + 1.25 (\geq 3.937)$						
Critical edge distance for splitting failure	c_{ac}	in. (mm)	See Section 4.1.10 of this report.						
Strength reduction factor for tension, concrete failure modes, Condition B ¹	ϕ	-	0.65						
Strength reduction factor for shear, concrete failure modes, Condition B ¹	ϕ	-	0.70						

For **SI**: 1 inch = 25.4 mm, 1lbf = 4.448 N, 1 psi = 0.006897 MPa.

For pound-inch units: 1 mm = 0.03937 inch, 1 N = 0.2248 lbf, 1MPa = 145.0 psi.

¹Values provided for post-installed anchors with category as determined from ACI 355.4 given for Condition B. Condition B applies without supplementary reinforcement or where pullout (bond) or pryout govern, as set forth in ACI 318 D.4.3, while condition A requires supplemental reinforcement. Values are for use with the load combinations of IBC Section 1605.2 or ACI 318 Section 9.2 as set forth in ACI 318 D.4.3. If the load combinations of ACI 318 Appendix C are used, the appropriate value of ϕ must be determined in accordance with ACI 318 D.4.4.

² d_o = drill hole diameter

TABLE 13—BOND STRENGTH DESIGN INFORMATION FOR FRACTIONAL THREADED ROD¹

DESIGN INFORMATION		Symbol	Units	Nominal rod diameter (in.)						
				$\frac{3}{8}$ "	$\frac{1}{2}$ "	$\frac{5}{8}$ "	$\frac{3}{4}$ "	$\frac{7}{8}$ "	1"	$1\frac{1}{4}$ "
Min. embedment depth		$h_{ef,min}$	in.	$2\frac{3}{8}$	$2\frac{3}{4}$	$3\frac{1}{8}$	$3\frac{1}{2}$	$3\frac{1}{2}$	4	5
			(mm)	(60)	(70)	(79)	(89)	(89)	(102)	(127)
Max. embedment depth		$h_{ef,max}$	in.	$7\frac{1}{2}$	10	$12\frac{1}{2}$	15	$17\frac{1}{2}$	20	25
			(mm)	(191)	(254)	(318)	(381)	(445)	(508)	(635)
Temperature range A ³	Characteristic bond strength in cracked concrete ²	$\tau_{k,cr}$	psi	942	826	826	797	739	710	696
			(N/mm ²)	(6.5)	(5.7)	(5.7)	(5.5)	(5.1)	(4.9)	(4.8)
	Characteristic bond strength in uncracked concrete ²	$\tau_{k,uncr}$	psi	1,754	1,638	1,551	1,493	1,435	1,392	1,319
			(N/mm ²)	(12.1)	(11.3)	(10.7)	(10.3)	(9.9)	(9.6)	(9.1)
Reduction for seismic tension		$\alpha_{N,seis}$	-	0.95			1.0			
Strength reduction factor for permissible installation conditions	Dry concrete	ϕ_d	-	0.65						
	Water saturated concrete	ϕ_{ws}	-	0.65						

For SI: 1 inch = 25.4 mm, 1 lbf = 4.448 N, 1 psi = 0.006897 MPa.

For pound-inch units: 1 mm = 0.03937 inch, 1 N = 0.2248 lbf, 1 MPa = 145.0 psi.

¹Characteristic bond strength values correspond to concrete compressive strength in the range $2,500 \text{ psi} \leq f_c \leq 4,500 \text{ psi}$. For the range $4,500 \text{ psi} < f_c \leq 6,500 \text{ psi}$ may be increased by 6% and range $6,500 \text{ psi} < f_c \leq 8,000 \text{ psi}$ tabulated characteristic bond strength may be increased by 10%.

²Characteristic bond strengths are for sustained loads including dead and live loads. For short-term loads including wind, bond strength may be increased 39 percent for temperature range A.

³Temperature range A: Maximum short term temperature = 162°F (72°C), Maximum long term Temperature = 122°F (50°C).

Short term elevated concrete temperatures are those that occur over brief intervals, e.g., as a results of diurnal cycling. Long term concrete temperatures are roughly constant over significant periods of time.

TABLE 14—STEEL DESIGN INFORMATION FOR FRACTIONAL REINFORCING BARS¹

DESIGN INFORMATION		Symbol	Units	Reinforcing bar size								
				#3	#4	#5	#6	#7	#8	#9	#10	#11
ROD OUTSIDE DIAMETER	d	in.		³ / ₈	¹ / ₂	⁵ / ₈	³ / ₄	⁷ / ₈	1	¹ / ₈	¹ / ₄	³ / ₈
		(mm)		(9.5)	(12.7)	(15.9)	(19.1)	(22.2)	(25.4)	(28.6)	(31.8)	(34.9)
ROD effective cross-sectional area	A_{se}	in ² .		0.11	0.20	0.31	0.44	0.60	0.79	1.00	1.27	1.56
		(mm ²)		(71)	(129)	(200)	(284)	(387)	(510)	(645)	(819)	(1006)
ASTM A615 Grade 40	Nominal strength as governed by steel strength	N_{sa}	lb	6,608	12,007	18,522	26,433	36,020	47,469	60,034	76,229	93,588
			(kN)	(29.4)	(53.4)	(82.4)	(117.6)	(160.2)	(211.1)	(267.0)	(339.1)	(416.5)
		V_{sa}	lb	3,965	7,204	11,113	15,860	21,612	28,481	36,020	45,737	56,153
			(kN)	(17.6)	(32.0)	(49.4)	(70.5)	(96.1)	(126.7)	(160.2)	(203.4)	(249.9)
	Reduction for seismic shear	$\alpha_{V,seis}$	-	0.74								
	Strength reduction factor ϕ for tension ²	ϕ	-	0.65								
Strength reduction factor ϕ for shear ²	ϕ	-	0.60									
ASTM A615 Grade 60	Nominal strength as governed by steel strength	N_{sa}	lb	9,913	18,010	27,783	39,650	54,030	71,203	90,051	114,343	140,370
			(kN)	(44.1)	(80.1)	(123.6)	(176.4)	(240.3)	(316.7)	(400.5)	(508.6)	(624.7)
		V_{sa}	lb	5,948	10,806	16,670	23,790	32,418	42,722	54,030	68,606	84,218
			(kN)	(26.5)	(48.1)	(74.1)	(105.8)	(144.2)	(190.0)	(240.3)	(305.2)	(374.8)
	Reduction for seismic shear	$\alpha_{V,seis}$	-	0.74								
	Strength reduction factor ϕ for tension ²	ϕ	-	0.65								
Strength reduction factor ϕ for shear ²	ϕ	-	0.60									
ASTM A706 Grade 60	Nominal strength as governed by steel strength	N_{sa}	lb	8,811	16,009	24,696	35,245	48,027	63,291	80,045	101,638	124,776
			(kN)	(39.2)	(71.2)	(109.8)	(156.8)	(213.6)	(281.5)	(356.0)	(452.1)	(555.3)
		V_{sa}	lb	5,287	9,605	14,818	21,147	28,816	37,975	48,027	60,983	74,870
			(kN)	(23.5)	(42.7)	(65.9)	(94.1)	(128.2)	(168.9)	(213.6)	(271.3)	(333.2)
	Reduction for seismic shear	$\alpha_{V,seis}$	-	0.74								
	Strength reduction factor ϕ for tension ²	ϕ	-	0.75								
Strength reduction factor ϕ for shear ²	ϕ	-	0.65									

For SI: 1 inch = 25.4 mm, 1lbf = 4.448 N, 1 psi = 0.006897 MPa.

For pound-inch units: 1 mm = 0.03937 inch, 1 N = 0.2248 lbf, 1MPa = 145.0 psi.

¹Values provided for common rod material types are based on specified strength and calculated in accordance with ACI 318-14 Eq. 17.4.1.2 and Eq. 17.5.1.2b or ACI 318-11 Eq. D-2 and Eq. D-29, as applicable. Nuts and washers must be appropriate for the rod strength and type.

²For use with load combinations Section 1605.2 of the IBC, ACI 318-14 5.3 or ACI 318-11 9.2, as applicable, as set forth in ACI 318-14 17.3.3 or ACI 318-11 D.4.3, as applicable. If the load combinations of ACI 318-11 Appendix C are used, the appropriate value of ϕ must be determined in accordance with ACI 318-11 D.4.4. Values correspond to a brittle steel element.

TABLE 15—CONCRETE BREAKOUT DESIGN INFORMATION FOR FRACTIONAL REINFORCING BAR¹

DESIGN INFORMATION	Symbol	Units	Reinforcing bar size								
			#3	#4	#5	#6	#7	#8	#9	#10	#11
Min. embedment depth	$h_{ef,min}$	in.	2 ³ / ₈	2 ³ / ₄	3 ¹ / ₈	3 ¹ / ₂	3 ¹ / ₂	4	4 ¹ / ₂	5	5 ¹ / ₂
		(mm)	(60)	(70)	(79)	(89)	(89)	(102)	(114)	(127)	(143)
Max. embedment depth	$h_{ef,max}$	in.	7 ¹ / ₂	10	12 ¹ / ₂	15	17 ¹ / ₂	20	22 ¹ / ₂	25	28
		(mm)	(191)	(254)	(318)	(381)	(445)	(508)	(572)	(635)	(716)
Effectiveness factor for cracked concrete	$k_{c,cr}$	in.lb	17								
		(SI)	7.1								
Effectiveness factor for uncracked concrete	$k_{c,uncr}$	in.lb	24								
		(SI)	10								
Min. anchor spacing	s_{min}	in. / (mm)	$s_{min} = c_{min}$								
Min. edge distance	c_{min}	in.	1.69	2.28	2.56	3.15	3.74	4.33	5.12	6.30	7.48
		(mm)	(43)	(58)	(65)	(80)	(95)	(110)	(130)	(160)	(190)
Minimum member thickness	h_{min}	in.	$h_{ef} + 1.25$ (≥ 3.937)		$h_{ef} + 2d_o^{2)}$						
		(mm)	$h_{ef} + 30$ (≥ 100)								
Critical edge distance for splitting failure	c_{ac}	in. / (mm)	See Section 4.1.10 of this report.								
Strength reduction factor for tension, concrete failure modes, Condition B ¹	ϕ	-	0.65								
Strength reduction factor for shear, concrete failure modes, Condition B ¹	ϕ	-	0.70								

For SI: 1 inch = 25.4 mm, 1lbf = 4.448 N, 1 psi = 0.006897 MPa.

For pound-inch units: 1 mm = 0.03937 inch, 1 N = 0.2248 lbf, 1MPa = 145.0 psi.

¹Values provided for post-installed anchors with category as determined from ACI 355.4 given for Condition B. Condition B applies without supplementary reinforcement or where pullout (bond) or pryout govern, as set forth in ACI 318 D.4.3, while condition A requires supplemental reinforcement. Values are for use with the load combinations of IBC Section 1605.2 or ACI 318 Section 9.2 as set forth in ACI 318 D.4.3. If the load combinations of ACI 318 Appendix C are used, the appropriate value of ϕ must be determined in accordance with ACI 318 D.4.4.

² d_o = drill hole diameter

TABLE 16—BOND STRENGTH DESIGN INFORMATION FOR FRACTIONAL REINFORCING BAR¹

DESIGN INFORMATION		Symbol	Units	Nominal rod diameter (in.)								
				#3	#4	#5	#6	#7	#8	#9	#10	#11
Min. embedment depth		$h_{ef,min}$	in.	2 ³ / ₈	2 ³ / ₄	3 ¹ / ₈	3 ¹ / ₂	3 ¹ / ₂	4	4 ¹ / ₂	5	5 ¹ / ₂
			(mm)	(60)	(70)	(79)	(89)	(89)	(102)	(114)	(127)	(143)
Max. embedment depth		$h_{ef,max}$	in.	7 ¹ / ₂	10	12 ¹ / ₂	15	17 ¹ / ₂	20	22 ¹ / ₂	25	28
			(mm)	(191)	(254)	(318)	(381)	(445)	(508)	(572)	(635)	(716)
Temperature range A ³	Characteristic bond strength in cracked concrete ²	$\tau_{k,cr}$	psi	797		826					696	
			(N/mm ²)	(5.5)		(5.7)					(4.8)	
	Characteristic bond strength in uncracked concrete ²	$\tau_{k,uncr}$	psi	1,348								739
			(N/mm ²)	(9.3)								(5.1)
Reduction for seismic tension		$\alpha_{N,seis}$	-	0.95					1.0			
Strength reduction factor for permissible installation conditions	Dry concrete	ϕ_d	-	0.65								
	Water saturated concrete	ϕ_{ws}	-	0.65								

For SI: 1 inch = 25.4 mm, 1 lbf = 4.448 N, 1 psi = 0.006897 MPa.
 For pound-inch units: 1 mm = 0.03937 inch, 1 N = 0.2248 lbf, 1 MPa = 145.0 psi.

¹Characteristic bond strength values correspond to concrete compressive strength in the range 2,500 psi ≤ f_c ≤ 4,500 psi. For the range 4,500 psi < f_c ≤ 6,500 psi may be increased by 6% and range 6,500 psi < f_c ≤ 8,000 psi tabulated characteristic bond strength may be increased by 10%.

²Characteristic bond strengths are for sustained loads including dead and live loads. For short-term loads including wind, bond strength may be increased 39 percent for temperature range A.

³Temperature range A: Maximum short term temperature = 162°F (72°C), Maximum long term Temperature = 122°F (50°C). Short term elevated concrete temperatures are those that occur over brief intervals, e.g., as a results of diurnal cycling. Long term concrete temperatures are roughly constant over significant periods of time.

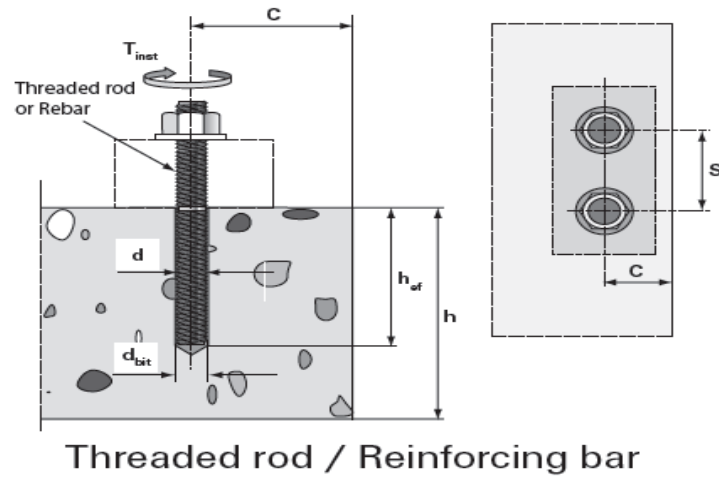
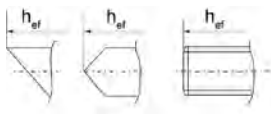

FIGURE 2—INSTALLATION PARAMETERS FOR THREADED RODS AND REINFORCING BARS

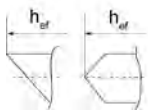

FIGURE 3—FIS EM ANCHORING SYSTEM & STEEL ELEMENTS

Alternative point geometry threaded rod FIS A



Alternative point geometry threaded rod RGM



Alternative head geometry threaded rod FIS A and RGM

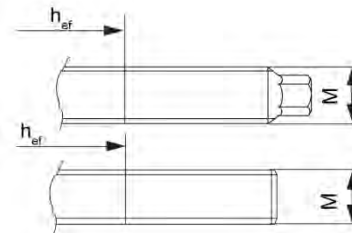

Marking (on the head):

- Property class 8.8 or high corrosion-resistant steel, property class 80: •
- Stainless steel A4, property class 70; high corrosion-resistant steel, property class 70 and property class 5.8: no marking

FIGURE 4—FISCHER THREADED RODS FIS A AND RGM

Installation instruction



see ICC-ES Evaluation Report No.1990 at www.icc-es.org

fischer adhesive anchoring system FIS EM

fischer FIS EM is an epoxy adhesive anchoring system for fastenings in normal weight concrete. **Important:** Before use, read and review the installation instructions and the SDS (safety data sheet). Do not use expired adhesive.

A Preparing the cartridge

1. Remove the cap by turning and pulling it off.
2. Insert the static mixer and lock it in place (turn to the right). **The spiral element mixer in the static mixer must be clearly visible.** Never use without the static mixer!
3. Place the cartridge in the dispenser.
4. Press approx. 10 cm of material out until the resin mortar comes out evenly grey in colour. Mortar which is not grey colour will not cure and must be disposed off.
5. The temperature of the concrete must be at least 50 °F (10 °C) and at most 104 °F (40 °C) (see Table VII). The temperature of the cartridge must be at least 41 °F (5 °C).
6. After finishing work, leave the static mixer attached to the cartridge.

Important: If the processing time is exceeded, use a new static mixer and if necessary remove encrusted material in the cartridge mouth.

B Installation

Important: Installation instructions - follow the pictograms 1-7 for the sequence of operating and refer to Tables I-VI for setting details. The construction drawings must be adhered. For any applications not covered by this document, or by any problems with installation contact fischer.

1. Drill hole with a hammer drill set. Observe the correct hole diameter and depth according to Tables I-VI.
- 2.1/2.2a/2.2b/2.3. Standing water in bore holes must be completely removed by blowing out before cleaning the bore hole. The drill hole must be blown out twice with compressed air (oil-free 87 psi (6 bar)), brushed two times (minimal by hand). For drill hole diameter ≥ 30 mm use a power drill.) Starting from the bottom of the hole and then again blown out twice with compressed air (oil-free 87 psi (6 bar)). The diameters of the brushes are given in Table I. Clean dirty brushes. Check brushes for wear (brush Ø drill hole Ø). If required use brush extension.
3. Fill approx. of the hole with mortar starting from the bottom of the hole. For drill hole depth > 150 mm use an extension tube. For drill hole diameter 40 mm use an fischer injection adapter. Observe processing time.
4. Anchoring element must be straight and free of oil and other contaminants. Mark the anchor with correct embedment depth. Press the anchoring element down to the bottom of the hole, turning it slightly while so doing. After insert the anchoring element, excess mortar must emerge from the mouth of the hole.
5. For overhead installations and applications between horizontal and overhead use the appropriate injection adapter and at least three wedges to support the anchor during curing time (the cartridge temperature must be 77 °F (25 °C)). Also use an injection adapter for all applications with a drill hole depth > 250 mm or a drill hole diameter do 40 mm. Use appropriate accessories to capture excess adhesive during installation of the anchor element in order to protect the unbonded portion of the anchor element from adhesive.
6. Do not disturb the anchoring element until cure time has elapsed. Do not apply load or installation torque moment to the anchor until the prescribed curing times are elapsed. The allowable working time and the minimum curing time are given in Table VII.
7. The installation torque moments are given in Table II.



Table VII. Processing and curing times.

Temperature range		Working time/ processing time [min]	Curing time [h]
[°C]	[°F]		
+10 - +14	+50 - +58	45	48
+15 - +19	+59 - +67	30	18
+20 - +29	+68 - +85	14	10
+30 - +40	+86 - +104	7	5

A FIS EM 390 S / FIS EM 585 S / FIS EM 1500 S

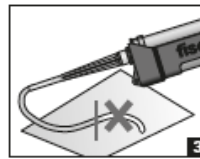
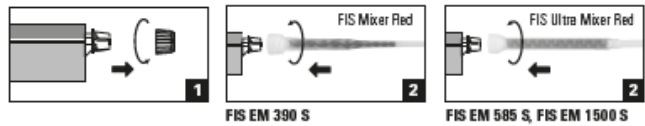

Cartridge	Dispenser	Item No.	Static mixer
390 ml	FIS DM S	511118	FIS Mixer Red
	FIS DC S	513423	
	FIS AP	058027	
585 ml	FIS DM S-L	510982	FIS Ultra Mixer Red
	FIS DP S-L	511125	
1500 ml	FIS DP S-XL	512401	

B

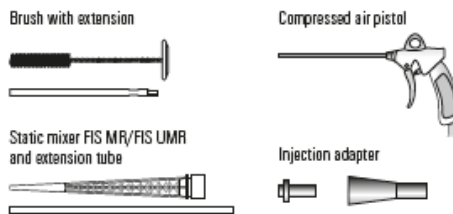
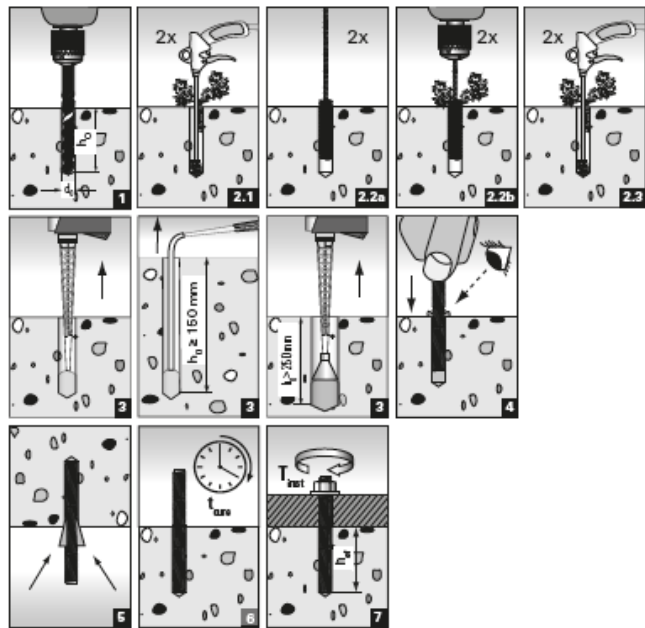
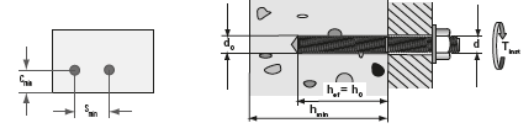

FIGURE 5—FIS EM INSTALLATION INFORMATION

Table I. Drill hole diameter / Accessories for metric sizes.

Drill bit		Rods	Rebar	Brush		Injection adapter	
ø [inch]	ø [mm]	ø [mm]	ø [mm]	Type	Item No.	Size	Color
7/16	12	M10	8	BS 12	78179	12	nature
9/16	14	M12	10	BS 14	78180	14	blue
5/8	16	-	12	BS 16/18	78181	16	red
3/4	18	M16	-	BS 16/18	78181	18	yellow
13/16	20	-	16	BS 20	52277	20	green
1	24	M20	-	BS 24	78182	24	nature
1	25	-	20	BS 25	97806	25	black
1 1/8	28	M24	-	BS 28	78183	28	nature
1 1/4	30	-	25	BS 35	78184	30	grey
1 3/8	35	M30	28	BS 35	78184	35	brown
1 1/2	40	-	32	BS 40	505061	40	red

Table II. Metric threaded rods.



d	d ₀	h _{ef, min}		h _{ef, max}		h _{min}		s _{min} = c _{min}		T _{inst}		
[mm]	[inch]	[mm]	[inch]	[mm]	[inch]	[mm]	[inch]	[mm]	[inch]	[Nm] [ft.-lb]		
M10	12	7/16	60	2,36	200	7,87	h _{ef} + 30	h _{ef} + 1,25	45	1,77	20	15
M12	14	9/16	70	2,76	240	8,45	h _{ef} + 30	h _{ef} + 1,25	55	2,17	40	30
M16	18	3/4	80	3,15	320	12,60	h _{ef} + 2d ₀	h _{ef} + 2d ₀	65	2,56	60	44
M20	24	1	90	3,54	400	15,75	h _{ef} + 2d ₀	h _{ef} + 2d ₀	85	3,35	120	89
M24	28	1 1/8	96	3,78	480	18,90	h _{ef} + 2d ₀	h _{ef} + 2d ₀	105	4,13	150	111
M30	35	1 3/8	120	4,72	600	23,62	h _{ef} + 2d ₀	h _{ef} + 2d ₀	140	5,51	300	221

Table III. Metric rebars.

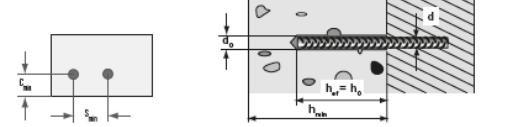

d	d ₀	h _{ef, min}		h _{ef, max}		h _{min}		s _{min} = c _{min}		T _{inst} *	
[mm]	[mm]	[mm]	[inch]	[mm]	[inch]	[mm]	[inch]	[mm]	[inch]	[Nm]	
10	14	9/16	60	2,36	200	7,87	h _{ef} + 30	h _{ef} + 1,25	45	1,77	30
12	16	5/8	70	2,76	240	9,45	h _{ef} + 30	h _{ef} + 1,25	55	2,17	50
16	20	13/16	80	3,15	320	12,60	h _{ef} + 2d ₀	h _{ef} + 2d ₀	65	2,56	110
20	25	1	90	3,54	400	15,75	h _{ef} + 2d ₀	h _{ef} + 2d ₀	85	3,35	190
25	30	1 1/4	100	3,94	500	19,69	h _{ef} + 2d ₀	h _{ef} + 2d ₀	110	4,33	280
28	35	1 3/8	112	4,41	560	22,05	h _{ef} + 2d ₀	h _{ef} + 2d ₀	130	5,12	350
32	40	1 1/2	128	5,04	640	25,20	h _{ef} + 2d ₀	h _{ef} + 2d ₀	160	6,30	430

* Torque moment only required when using threaded reinforcing bars to resist seismic loading.

Table IV. Drill hole diameter / Accessories for fractional sizes.

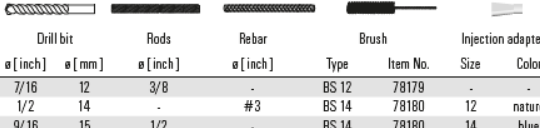

Drill bit		Rods	Rebar	Brush		Injection adapter	
ø [inch]	ø [mm]	ø [inch]	ø [inch]	Type	Item No.	Size	Color
7/16	12	3/8	-	BS 12	78179	-	-
1/2	14	-	#3	BS 14	78180	12	nature
9/16	15	1/2	-	BS 14	78180	14	blue
5/8	16	-	#4	BS 16/18	78181	16	red
3/4	18	5/8	-	BS 20	52277	18	yellow
3/4	20	-	#5	BS 20	52277	18	yellow
7/8	22	3/4	#6	BS 20	52277	20	green
1	25	7/8	-	BS 25	97806	25	black
1 1/8	28	1	#7	BS 28	78183	28	nature
1 1/4	32	1 1/8	#8	BS 35	78184	30	grey
1 3/8	35	1 1/4	#9	BS 35	78184	35	brown
1 1/2	40	-	#10	BS 40	505061	40	red

Table V. Fractional threaded rods.

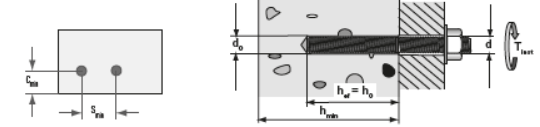

d	d ₀	h _{ef, min}		h _{ef, max}		h _{min}		s _{min} = c _{min}		T _{inst}		
[mm]	[inch]	[mm]	[inch]	[mm]	[inch]	[mm]	[inch]	[mm]	[inch]	[Nm] [ft.-lb]		
3/8	12	7/16	60	2,38	191	7,50	h _{ef} + 30	h _{ef} + 1,25	42,5	1,67	20	15
1/2	15	9/16	70	2,75	254	10,00	h _{ef} + 30	h _{ef} + 1,25	57,5	2,26	41	30
5/8	18	3/4	79	3,13	318	12,50	h _{ef} + 2d ₀	h _{ef} + 2d ₀	65	2,56	68	50
3/4	22	7/8	89	3,50	381	15,00	h _{ef} + 2d ₀	h _{ef} + 2d ₀	80	3,15	122	90
7/8	25	1	89	3,50	445	17,50	h _{ef} + 2d ₀	h _{ef} + 2d ₀	95	3,74	136	100
1	28	1 1/8	102	4,00	508	20,00	h _{ef} + 2d ₀	h _{ef} + 2d ₀	110	4,33	183	135
1 1/8	32	1 1/4	114	4,50	572	22,50	h _{ef} + 2d ₀	h _{ef} + 2d ₀	135	5,31	244	180
1 1/4	35	1 3/8	127	5,00	635	25,00	h _{ef} + 2d ₀	h _{ef} + 2d ₀	160	6,30	325	240

Table VI. Fractional reinforcing bars.

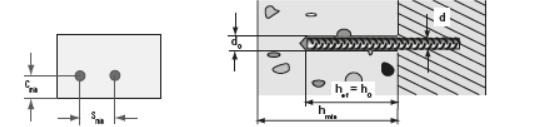

d	d ₀	h _{ef, min}		h _{ef, max}		h _{min}		s _{min} = c _{min}		T _{inst} *	
[mm]	[inch]	[mm]	[inch]	[mm]	[inch]	[mm]	[inch]	[mm]	[inch]	[Nm]	
#3	14	1/2	60	2,38	191	7,50	h _{ef} + 30	h _{ef} + 1,25	43	1,69	30
#4	16	5/8	70	2,75	254	10,00	h _{ef} + 30	h _{ef} + 1,25	58	2,28	60
#5	20	3/4	79	3,13	318	12,50	h _{ef} + 2d ₀	h _{ef} + 2d ₀	65	2,56	110
#6	22	7/8	89	3,50	381	15,00	h _{ef} + 2d ₀	h _{ef} + 2d ₀	80	3,15	175
#7	28	1 1/8	89	3,50	445	17,50	h _{ef} + 2d ₀	h _{ef} + 2d ₀	95	3,74	240
#8	32	1 1/4	102	4,00	508	20,00	h _{ef} + 2d ₀	h _{ef} + 2d ₀	110	4,33	320
#9	35	1 3/8	114	4,50	572	22,50	h _{ef} + 2d ₀	h _{ef} + 2d ₀	130	5,12	380
#10	40	1 1/2	127	5,00	635	25,00	h _{ef} + 2d ₀	h _{ef} + 2d ₀	160	6,30	450
#11	45	1 3/4	140	5,50	699	27,50	h _{ef} + 2d ₀	h _{ef} + 2d ₀	175	6,89	450

* Torque moment only required when using threaded reinforcing bars to resist seismic loading.

FIGURE 5—FIS EM INSTALLATION INFORMATION (Continued)

ICC-ES Evaluation Report

ESR-1990 FBC Supplement

Reissued September 2017

Revised November 2017

This report is subject to renewal September 2019.

www.icc-es.org | (800) 423-6587 | (562) 699-0543

A Subsidiary of the International Code Council®

DIVISION: 03 00 00—CONCRETE

Section: 03 16 00—Concrete Anchors

DIVISION: 05 00 00—METALS

Section: 05 05 19—Post-Installed Concrete Anchors

REPORT HOLDER:

fischerwerke GmbH & Co. KG

KLAUS-FISCHER-STRASSE 1

72178 WALDACHTAL

GERMANY

+49 7443 120

www.fischerwerke.de

EVALUATION SUBJECT:

fischer FIS EM ADHESIVE ANCHORING SYSTEM FOR CRACKED AND UNCRACKED CONCRETE

1.0 REPORT PURPOSE AND SCOPE

Purpose:

The purpose of this evaluation report supplement is to indicate that the fischer FIS EM Adhesive Anchoring System, recognized in ICC-ES master evaluation report ESR-1990, has also been evaluated for compliance with the codes noted below.

Applicable code editions:

- 2014 *Florida Building Code—Building*
- 2014 *Florida Building Code—Residential*

2.0 CONCLUSIONS

The fischer FIS EM Adhesive Anchoring System, described in Sections 2.0 through 7.0 of the master evaluation report ESR-1990, complies with the *Florida Building Code—Building* and the *Florida Building Code—Residential*, provided the design and installation are in accordance with the 2012 *International Building Code*® (IBC) provisions noted in the master report, and the following conditions:

- Design wind loads must be based on Section 1609 of the *Florida Building Code—Building* or Section R301.2.1.1 of the *Florida Building Code—Residential*, as applicable.
- Load combinations must be in accordance with Section 1605.2 or Section 1605.3 of the *Florida Building Code—Building*, as applicable.

Use of the fischer FIS EM Adhesive Anchoring System with stainless steel threaded rod materials has also been found to be in compliance with the High-Velocity Hurricane Zone provisions of the *Florida Building Code—Building* and the *Florida Building Code—Residential* when the following conditions are met:

- The design wind loads for use of the anchors in the High-velocity Hurricane Zone are based on Section 1620 of the *Florida Building Code—Building*, as applicable.
- When complying with the 2010 *Florida Building Code—Building* or the 2010 *Florida Building Code—Residential*, reinforcing bars must be in accordance with Section 1922.4.

Use of the fischer FIS EM Adhesive Anchoring System with carbon steel fischer anchor rods, carbon standard steel threaded rod materials and reinforcing bars for compliance with the High-velocity Hurricane Zone provisions of the *Florida Building Code—Building* and the *Florida Building Code—Residential* has not been evaluated and is outside the scope of the supplemental report.

For products falling under Florida Rule 9N-3, verification that the report holder's quality-assurance program is audited by a quality-assurance entity approved by the Florida Building Commission for the type of inspections being conducted is the responsibility of an approved validation entity (or the code official, when the report holder does not possess an approval by the Commission).

This supplement expires concurrently with the master report, reissued September 2017 and revised October 2017.