

Perspektive
Schloss:

T-AV3-U2218469 .../D A9 92/... M2 RS
DIN LS spiegelbildlich

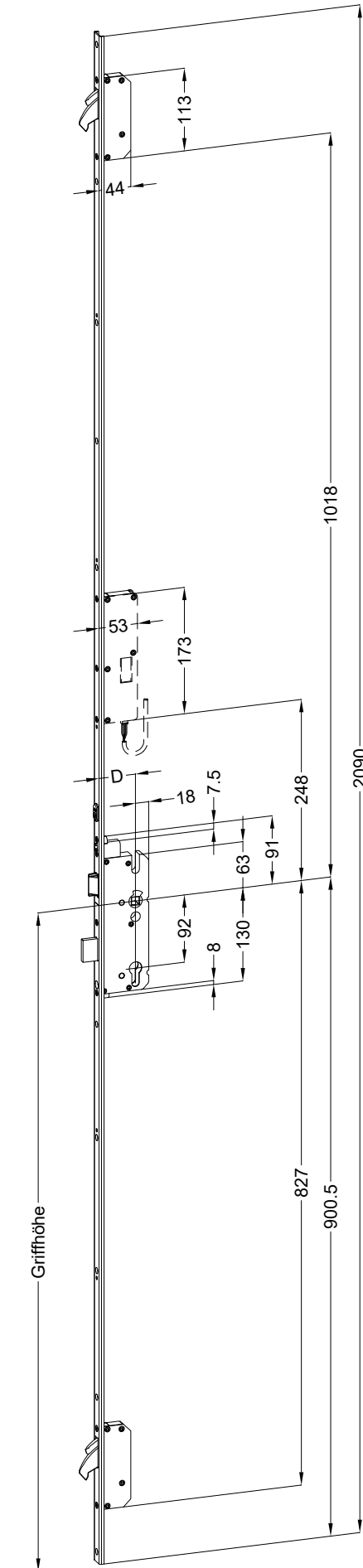

Technische Änderungen vorbehalten!

Schraublage
Schloss:

T-AV3-U2218469 .../D A9 92/... M2 RS
DIN LS spiegelbildlich

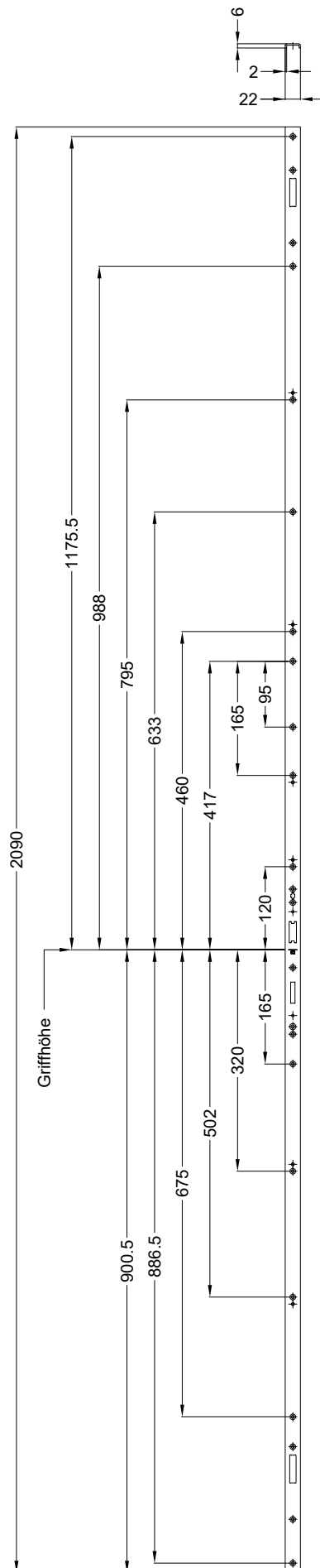

Technische Änderungen vorbehalten!

Ansichten
Schloss:

T-AV3-U2218469 .../D A9 92/... M2 RS
DIN LS spiegelbildlich

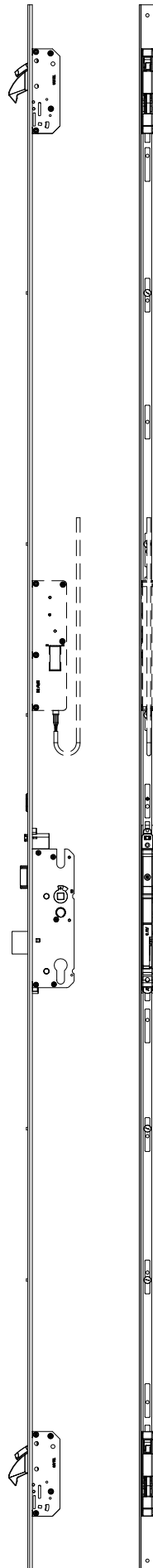

Technische Änderungen vorbehalten!

Fräsmaße
Schloss:

T-AV3-U2218469 .../D A9 92/... M2 RS
DIN LS spiegelbildlich



Empfohlene Fräsung

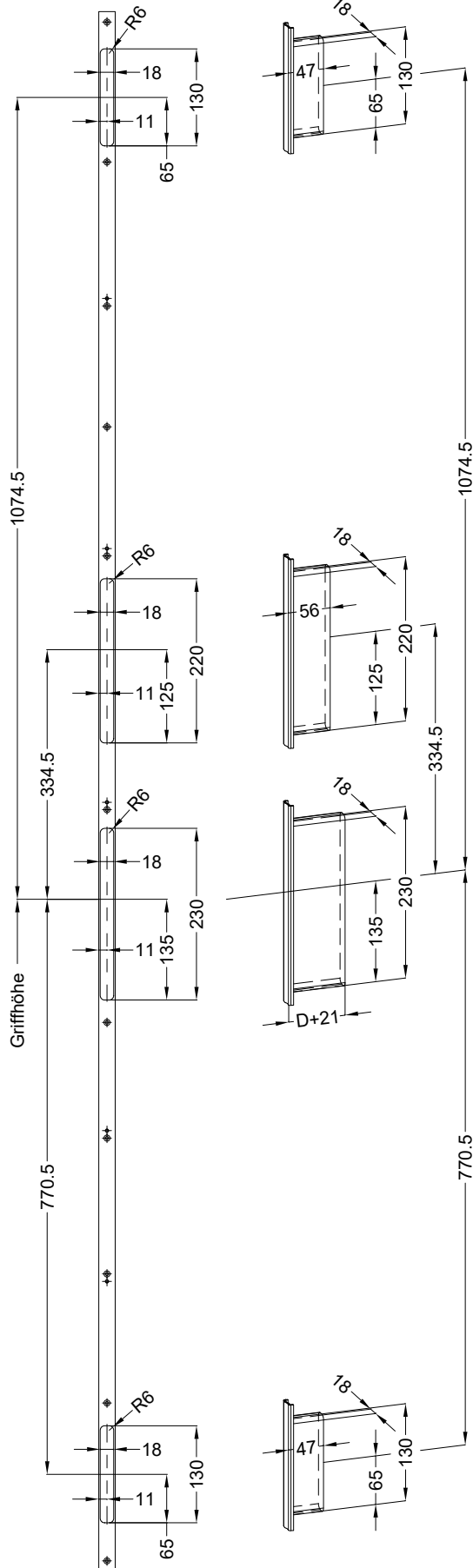
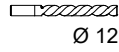

Technische Änderungen vorbehalten!

Einbausituationen der Bauteile mit Fräsmaßen

**Schloss: T-AV3-U2218469 .../D A9 92/... M2 RS
DIN LS spiegelbildlich**



Allgemeine Vermaung

Frsmae

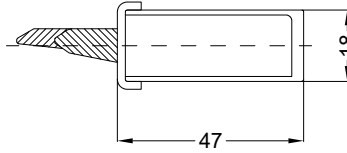
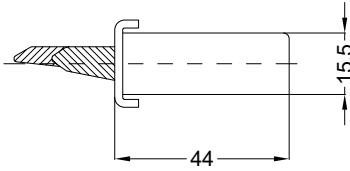

Situation
Schwenkriegel
TM AV3 SK RS

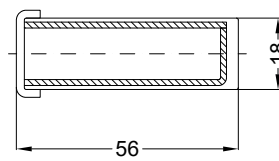
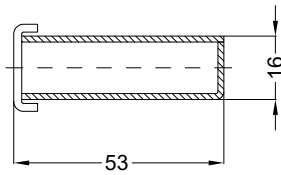

Situation
Motorkasten EAV

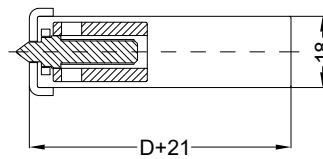
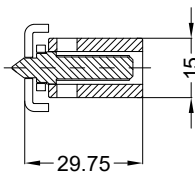

Situation
Taststift
SK AV3

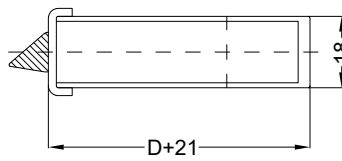
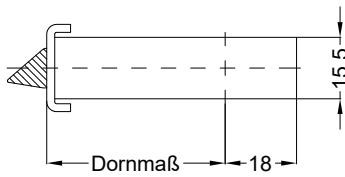

Situation
Falle
SK AV3

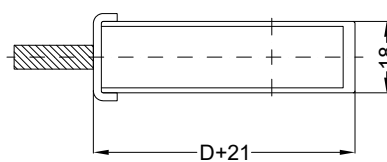
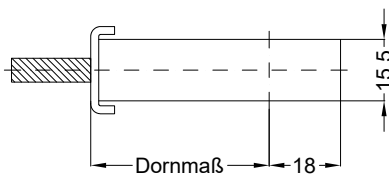

Situation
Riegel
SK AV3

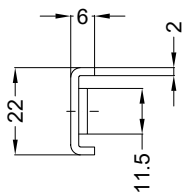

Lage
Schloss

Katalogdarstellung

Schloss: T-AV3-U2218469 .../D A9 92/... M2 RS
DIN LS spiegelbildlich



Empfohlene Fräsung

