

Schraublage
Schloss:

T-BM-EN179/1125-U2460 .../DS 92/... M2

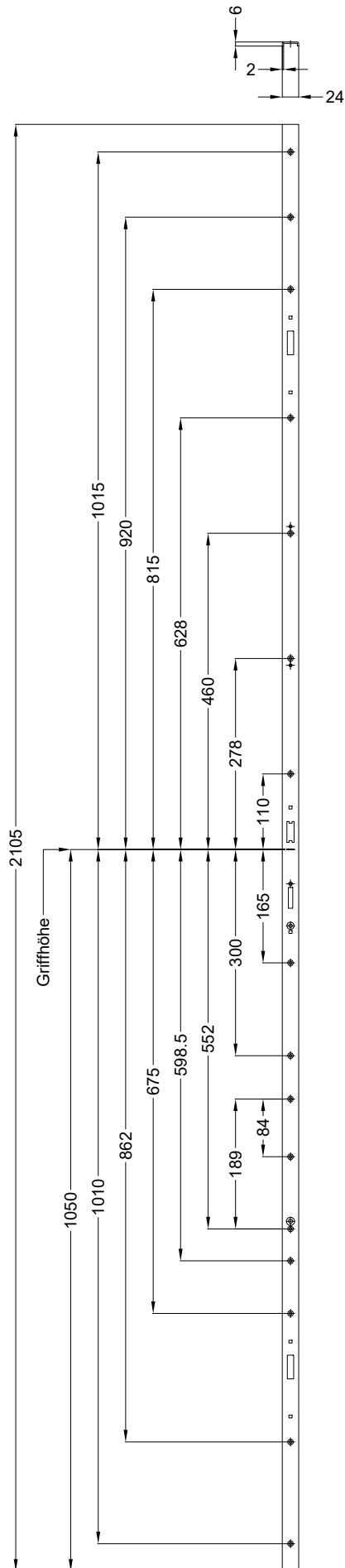

Technische Änderungen vorbehalten!



Ansichten
Schloss:

T-BM-EN179/1125-U2460 .../DS 92/... M2

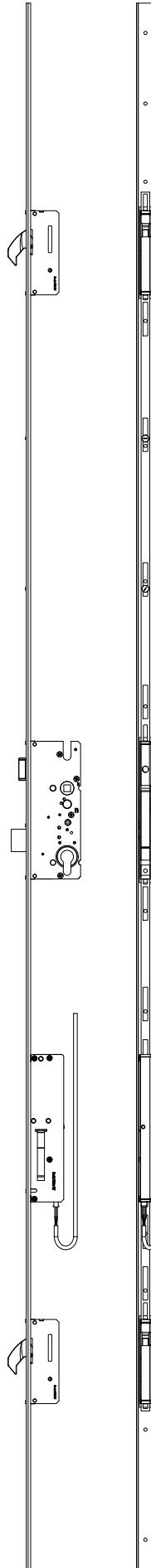

Technische Änderungen vorbehalten!

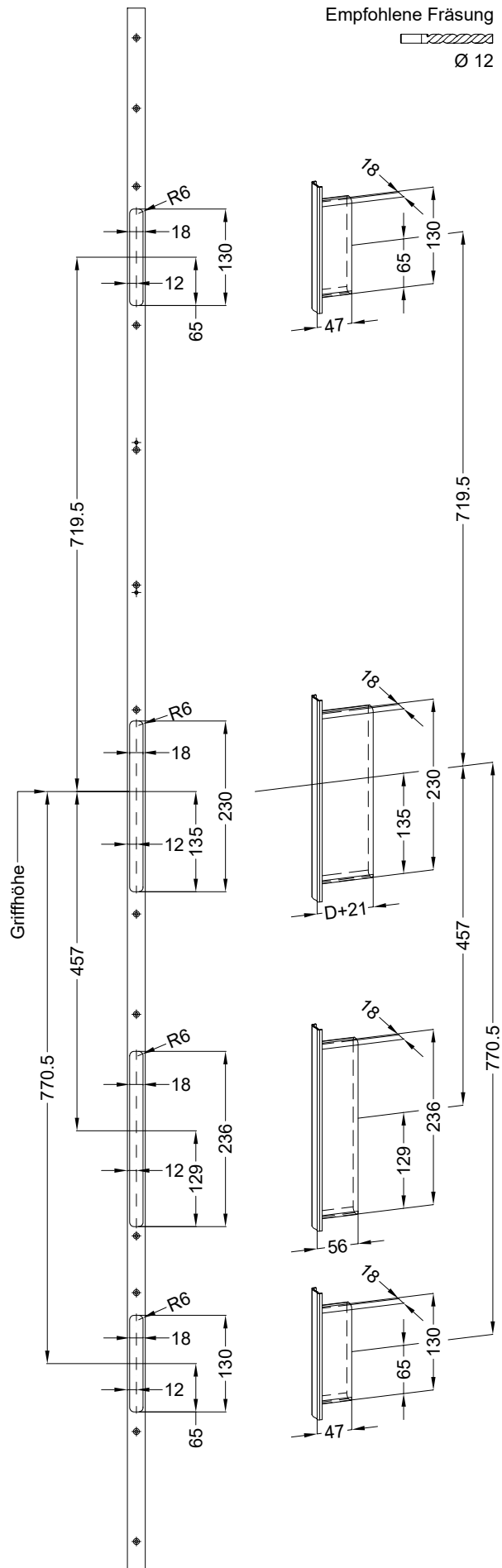

Einbausituationen der Bauteile mit Fräsmaßen

Schloss: T-BM-EN179/1125-U2460 .../DS 92/... M2



Allgemeine Vermaung

Frsmae

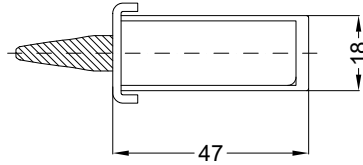
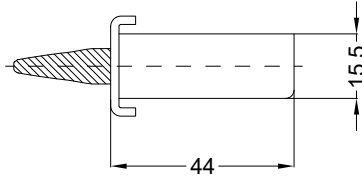

Situation
Schwenkriegel

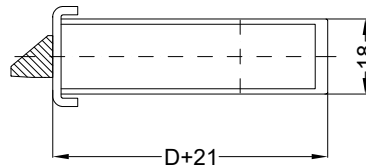
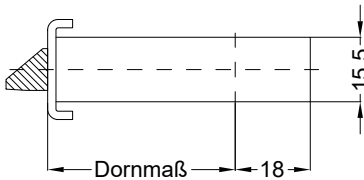

Situation
Falle

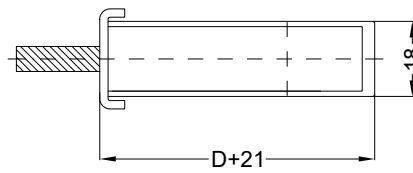
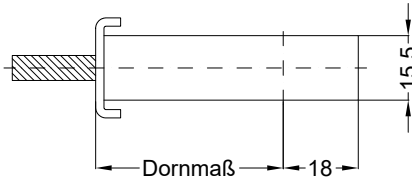

Situation
Riegel

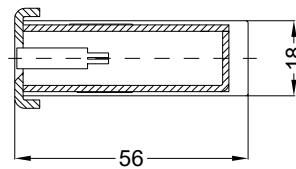
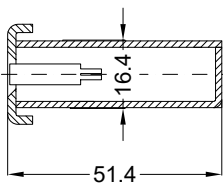

Situation
Motorkasten

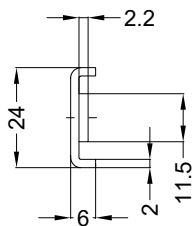

Lage
Schloss

Technische Änderungen vorbehalten!

