

Schraublage  
Schloss:

STV-F 167762/D... 92/... M2

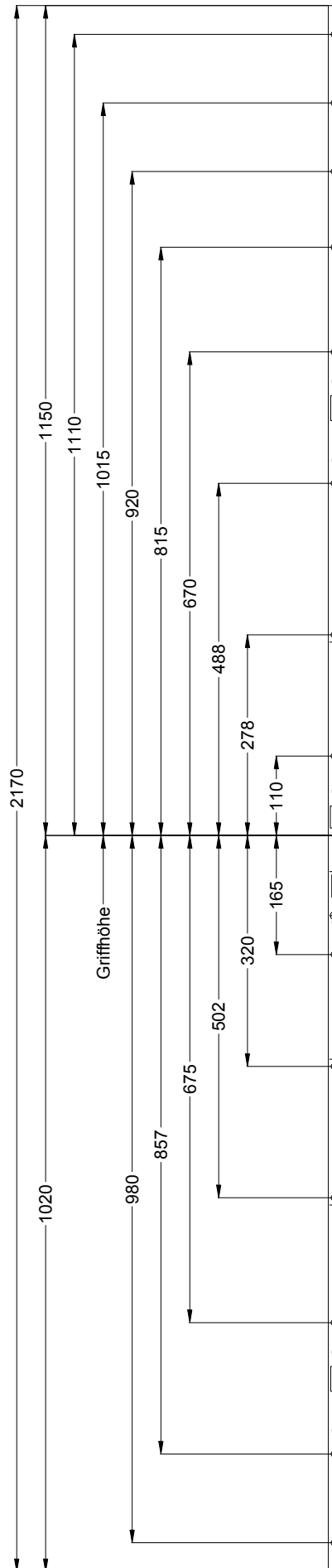

Technische Änderungen vorbehalten!

Ansichten  
Schloss:

STV-F 167762/D... 92/... M2

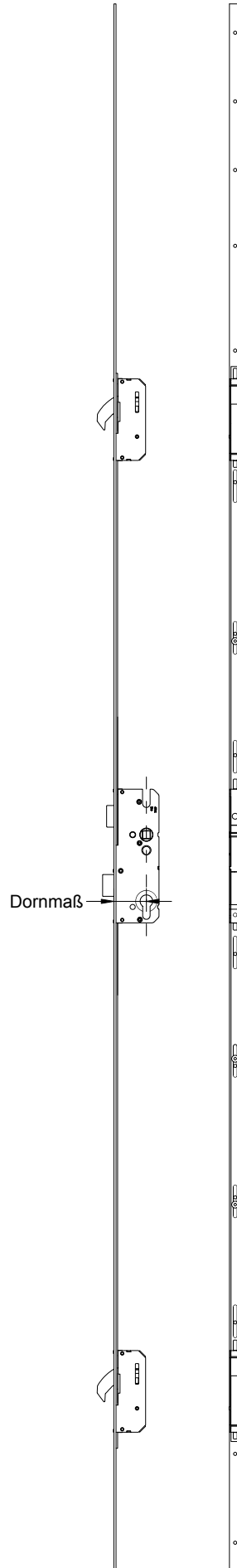

Technische Änderungen vorbehalten!

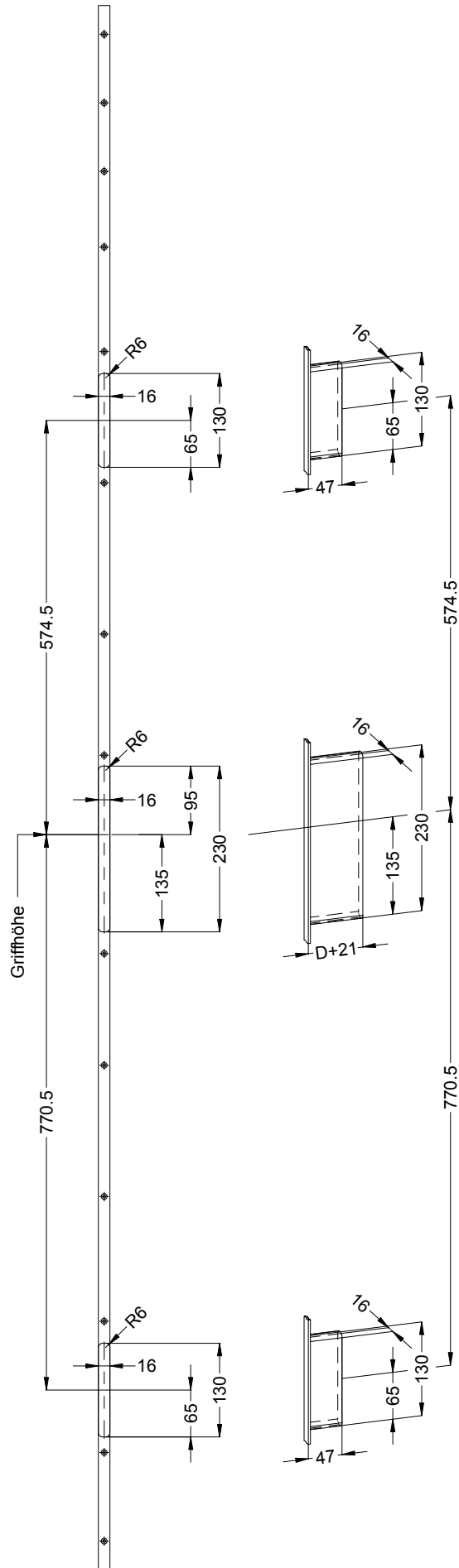

Allgemeine Vermaung

Frsmae

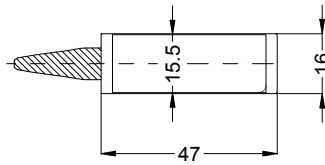
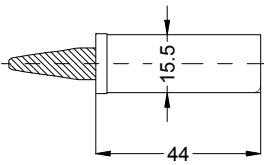

Situation  
Schwenkriegel

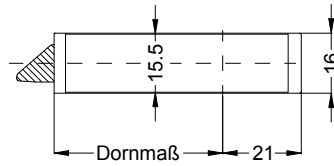
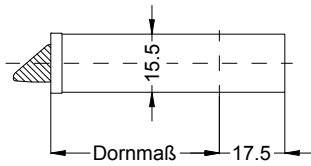

Situation  
Falle

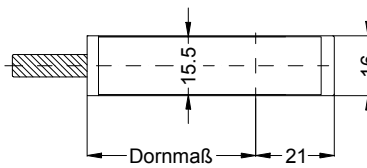
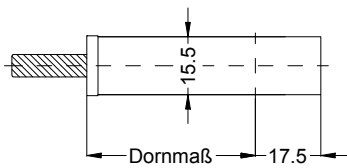

Situation  
Riegel

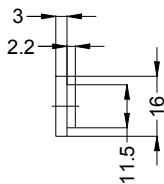

Lage  
Schloss

Technische Änderungen vorbehalten!

