

Schraublage
Schloss:

T-FGPAW1660 .../DS 92/... M2

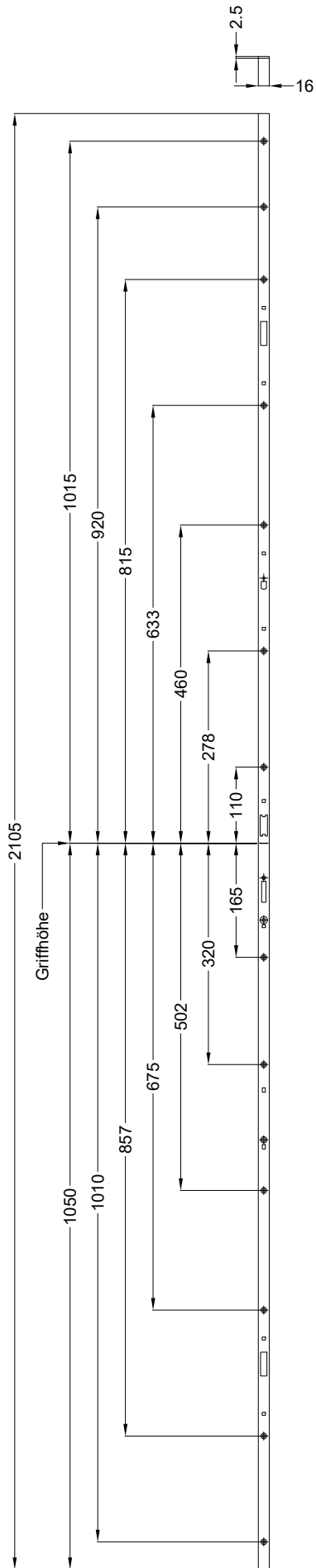

Technische Änderungen vorbehalten!

Ansichten
Schloss:

T-FGPAW1660 .../DS 92/... M2

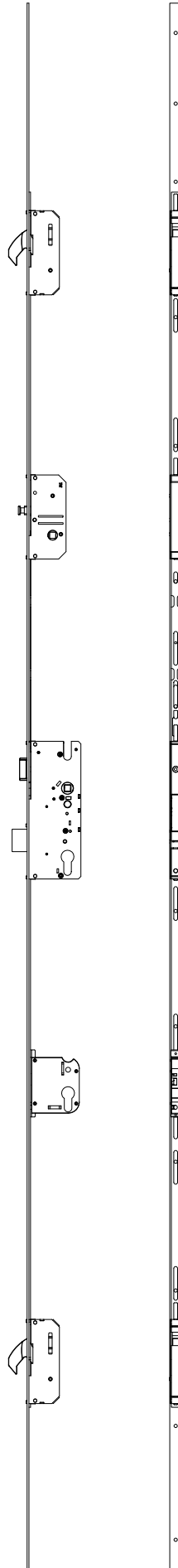

Technische Änderungen vorbehalten!

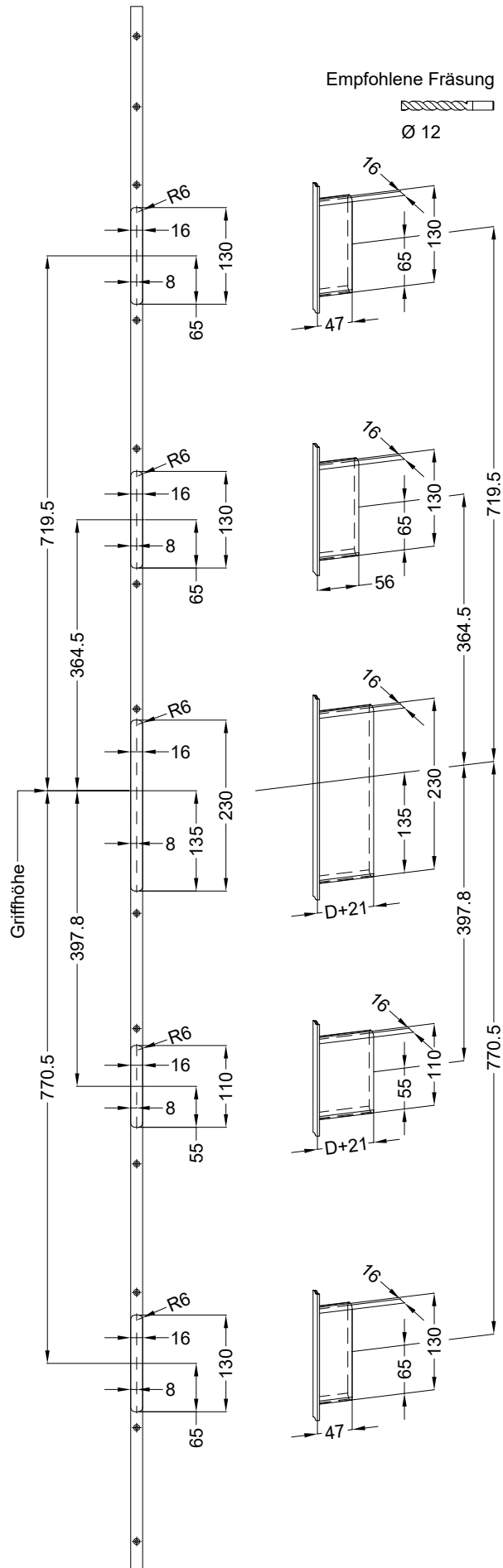

Allgemeine Vermaung

Frsmae

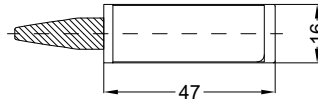
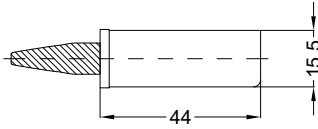

Situation
Schwenkriegel

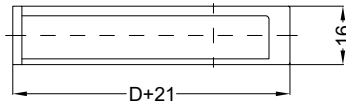
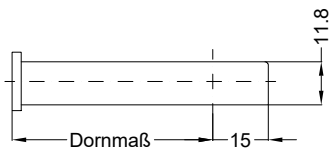

Situation
Zusatzschloss

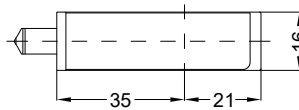
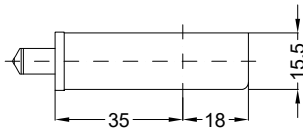

Situation
Trwchter

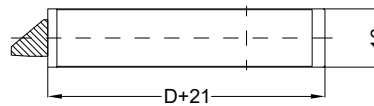
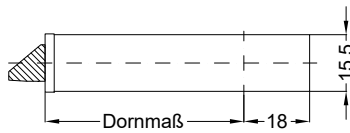

Situation
Falle

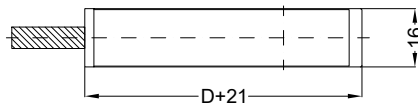
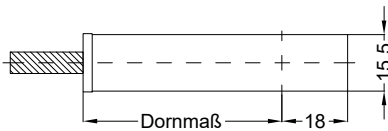

Situation
Riegel

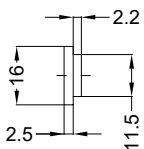

Lage
Schloss

