

Schraublage
Schloss: T-FG1685 .../D 92/... R2

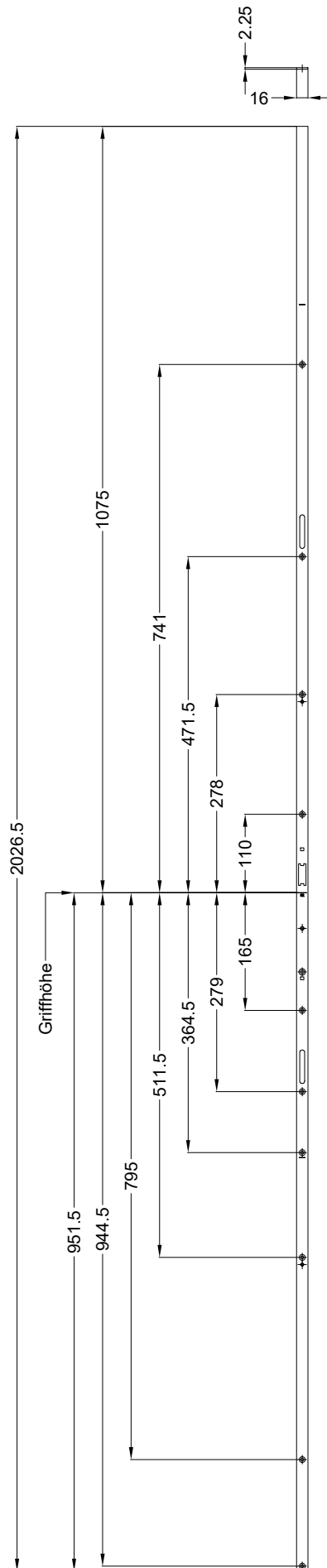

Ansichten

Schloss: T-FG1685 .../D 92/... R2

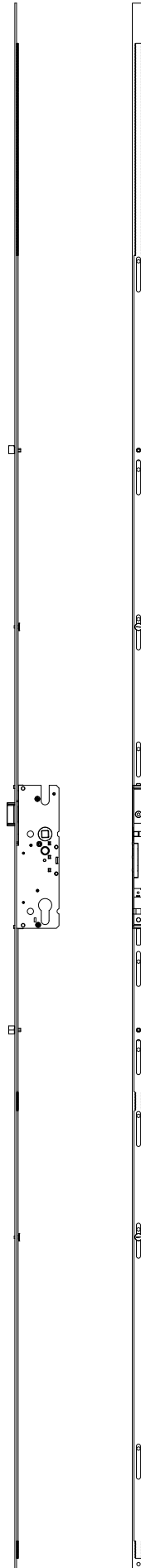

Technische Änderungen vorbehalten!

Fräsmaße

Schloss: T-FG1685 .../D 92/... R2

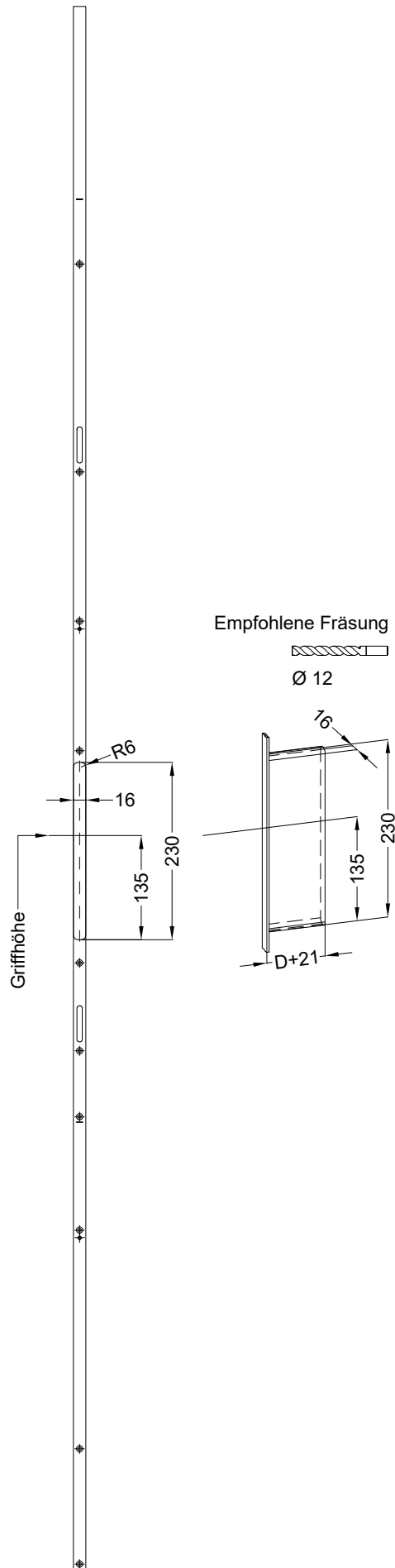

Allgemeine Vermaung

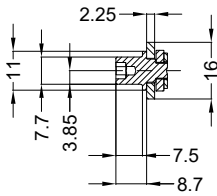

Frsmae

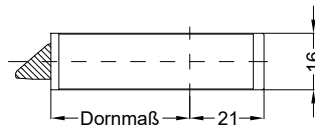
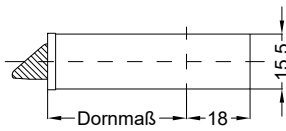

Situation
 Schliessbolzen
 Exzentrerschliebolzen SL

Situation
 Falle

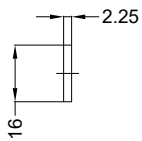

Lage
 Schloss

