

Perspektive

Schloss: T-F2060 .../D 88/8,5 M2 RS
DIN LS spiegelbildlich

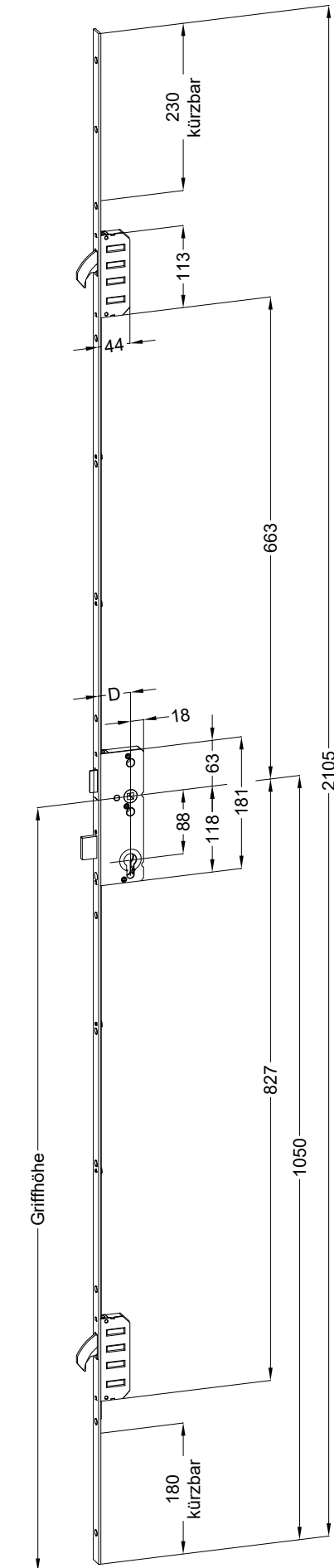

Technische Änderungen vorbehalten!

Schraublage
Schloss: T-F2060 .../D 88/8,5 M2 RS
DIN LS spiegelbildlich

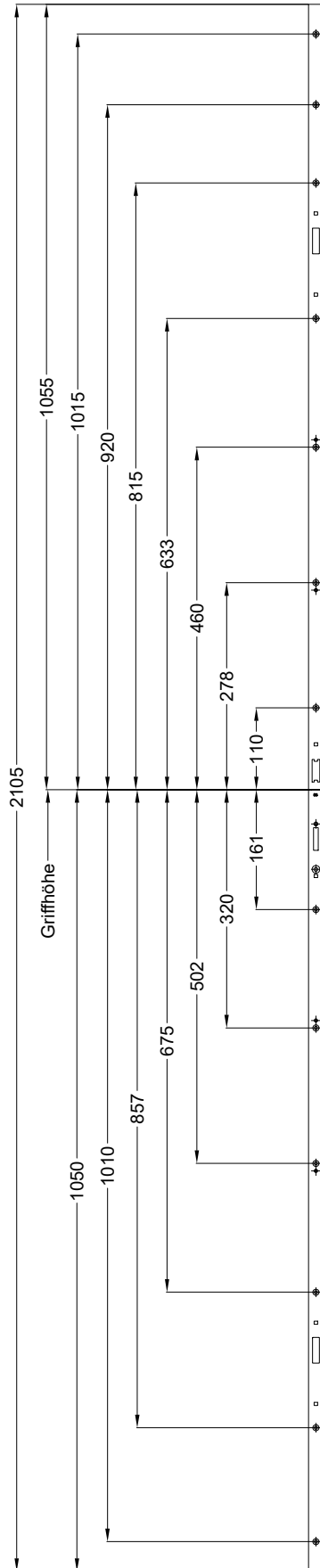
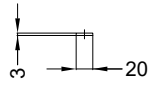

Ansichten

**Schloss: T-F2060 .../D 88/8,5 M2 RS
DIN LS spiegelbildlich**

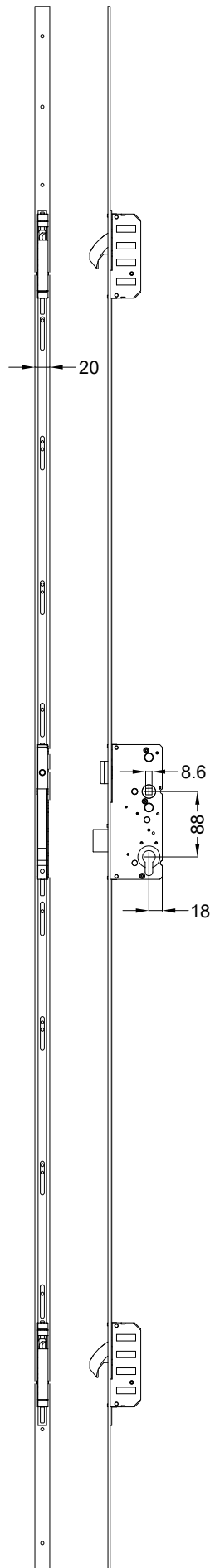

Einbausituationen der Bauteile mit Fräsmaßen

Schloss: T-F2060 .../D 88/8,5 M2 RS

DIN LS spiegelbildlich



Allgemeine Vermaung

Frsmae

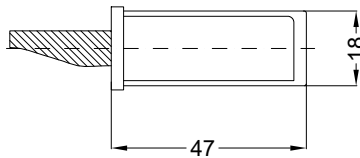
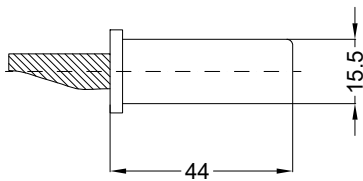

Situation
Schwenkriegel TS1

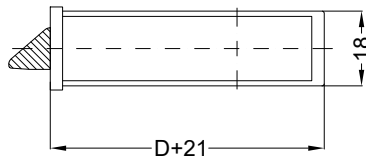
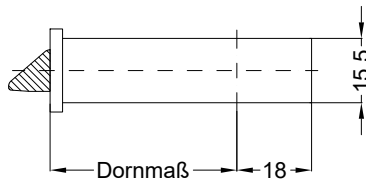

Situation
Falle

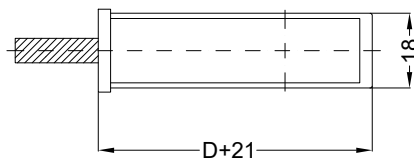
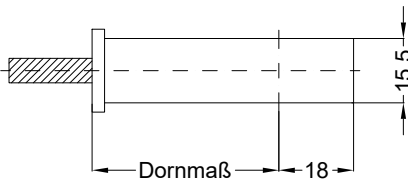

Situation
Riegel

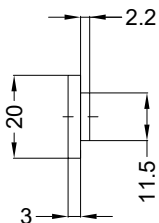

Lage
Schloss

Katalogdarstellung

Schloss: T-F2060 .../D 88/8,5 M2 RS
DIN LS spiegelbildlich

